

Television  
BRAVIA

Use this Help Guide if you have any questions on how to use your TV.

You can also find comprehensive and up-to-date information about your TV on the Help Guide (Online). For details, see [“How to Use the Help Guide.”](#)

## Basic Operations



### [How to Use the Remote control](#)

You can use either the IR (infrared) Remote Control or the Touchpad Remote Control (supplied or optional, depending on your model/region/country).



### [How to Use the Help Guide](#)

You can find comprehensive and up-to-date information about your TV on the Help Guide (Online). You can also view it on your PC or mobile device.



### [Home Menu Screen](#)

You can access various contents and apps from the Home Menu screen.



### [Using the DISCOVER button](#)

You can use the DISCOVER button to search for content (such as TV programs, Internet content, etc.).



### [Using “Action Menu”](#)

“Action Menu” provides quick access to the functions that are available for the currently displayed screen.



## [Enjoying TV Programs](#)



## [Playing TV Sound through Other Devices](#)



## [Watching/Listening to Connected Devices](#)



[Using with Smartphones/Tablets](#)

---



[Connecting to a Network](#)

---



[Using a Home Network](#)

---



[Settings](#)

---



[Troubleshooting](#)

---



C-041-100-15(1)

Copyright 2015 Sony Corporation



Television

Enjoying TV Programs

---

[Watching TV programs](#)



[Watching in 3D \(3D models only\)](#)



[Using SNS to enjoy programs with friends](#)

---





Television

## Playing TV Sound through Other Devices

---

[Connecting an audio system](#)



[Connecting the Wireless Subwoofer \(optional\)](#)



[Using the BRAVIA Sync function to operate another device](#)





Television

## Watching/Listening to Connected Devices

---

[Viewing photos in 4K from compatible devices \(4K models only\)](#)



[Connecting a BD/DVD player](#)



[Connecting a PC/digital still camera/camcorder](#)



[Connecting a USB device](#)



[Using the BRAVIA Sync function to operate another device](#)



[Connecting an IR Blaster \(IR Blaster compatible models only\)](#)





Television

Using with Smartphones/Tablets

---

[Displaying the screen of a smartphone/tablet on the TV](#)



[Sharing photos/music/videos stored on smartphones/tablets](#)



[Using a smartphone/tablet to operate the TV](#)

---





Television

## How to Use the Help Guide

There are two versions of the Help Guide for your TV: Help Guide (Built-in) and Help Guide (Online). The Help Guide (Built-in) includes basic information and instructions to use your TV. If your TV is connected to the Internet, the Help Guide (Online) provides you comprehensive and up-to-date information about your TV and network services. You can also use your PC or mobile device to view the Help Guide (Online).



1. Connect the TV to the Internet.
2. Select  [Switch to Online] (A) at the upper right of the screen to switch to the Help Guide (Online).

If your Internet connection is too slow or unstable and cannot display the Help Guide (Online) smoothly, perform step 2 again with selecting  [Switch to Built-in].

To view the Help Guide (Online) on your PC or mobile device

[http://rd1.sony.net/help/tv/ccol1/h\\_co/](http://rd1.sony.net/help/tv/ccol1/h_co/)



### Note

- The images and illustrations used in the Help Guide may differ depending on your TV model.
- Design and specifications are subject to change without notice.

### Hint

- You can also use “TV SideView” to view the Help Guide (Online).
- To see if your TV is equipped with one of the functions described in the Help Guide, refer to a paper manual or catalog.
- This Help Guide is written for all regions/countries and some descriptions contained in this Help Guide are not applied to some regions/countries.
- For the parts and controls of your TV and remote control, refer to a paper manual supplied with this TV.

Related Topic

- Using a smartphone/tablet installed with “TV SideView”
- Connecting to a network using a LAN Cable
- Connecting to a network using a wireless connection

C-041-100-15(1)

Copyright 2015 Sony Corporation



## How to Use the Remote control

You can use an IR (infrared) Remote Control to operate the TV. For models that are compatible with Touchpad Remote Controls, you can use a Touchpad Remote Control to operate the TV. To confirm whether your TV is compatible with Touchpad Remote Controls, refer to a paper manual supplied with this TV.

### Using the IR Remote Control

Operate the many functions of this TV using the / / / and buttons.

1. Move the focus to an item using the / / / buttons.

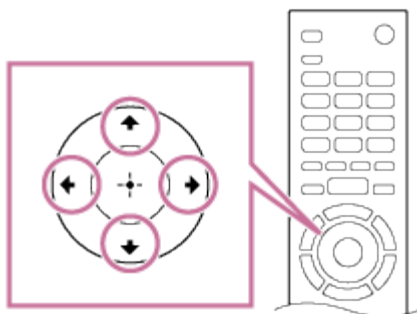

2. Press the button to select the item.

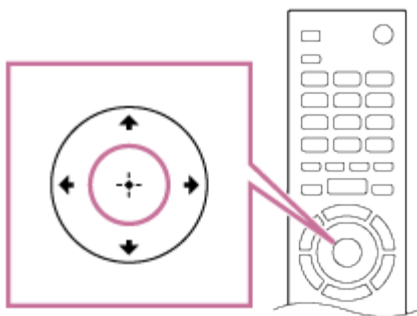

To return to the previous screen

Press the BACK button.



To operate the TV by the Voice search (only remote controls with the button)

For remote controls with the button, press the button and speak into the microphone that is built into the remote control.

**Note**

- To use the Voice search function, an Internet connection is required.

When your voice is not being recognized

Make sure to activate the  button on the remote control with the  button, or register the remote control with the  button to your TV. To confirm these settings, press the HOME button, then select [Settings] — Remote control settings.

If viewing the Help Guide (Online) on the TV, select [Switch to Built-in] at the upper right of the screen. The link that leads to the setting screen will appear.

## Using the Touchpad Remote Control

Whether a Touchpad Remote Control is supplied with the TV depends on your model/region/country.

Basic operation of this TV's functions and settings can be done by sliding and pressing the touchpad.

You may need to pair your Touchpad Remote Control with the TV before use. Press the HOME button on the IR Remote Control, select [Settings] — [Touchpad Remote Control settings] — [Pair Touchpad Remote Control], then follow the on-screen instructions to pair your Touchpad Remote Control.

1. Slide your finger across the touchpad to move the focus to an item.

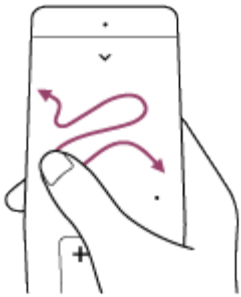

2. Press the touchpad until it clicks to select the item.

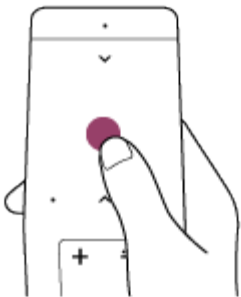

To quickly move the focus on the screen

Slide your finger until the focus starts changing rapidly, and keep your finger on the touchpad.

To return to the previous screen

Press the BACK button.

To configure the Touchpad Remote Control settings

Press the HOME button, then select [Settings] — [Touchpad Remote Control settings] — the desired option.

To launch the Touchpad Remote Control Introduction/Tutorial

Press the HOME button, then select [Settings] — [Touchpad Remote Control settings] — [Start Introduction/Tutorial].

To scroll vertically or horizontally in the pre-installed browser screen

Slide your finger up/down or left/right in the following areas.

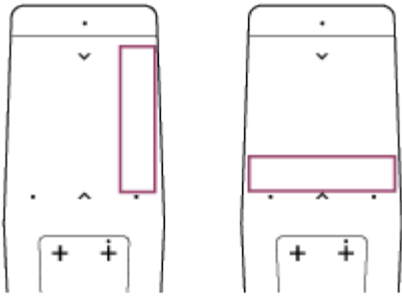

C-041-100-15(1)

Copyright 2015 Sony Corporation

Television

## Home Menu Screen

The Home Menu provides a search function, contents recommendations, and access to apps and settings. Available items vary depending on your setup region/country and the situation.



## Using search

You can search for various content. You can enter a search keyword using the on-screen keyboard or by dictating it.

1. Press the HOME button.
2. Select the search box.
3. Enter a search keyword using the on-screen keyboard or speaking into the microphone.

## Selecting content, an app or setting an item

1. Press the HOME button.
2. Select the desired item from the desired category.

## Category list

- Recommendations  
This category shows content based on your history.
- [Featured apps], [Apps] and [Games]  
These categories provide access to apps (such as Video, Album, Music, Photo Sharing Plus, and Screen mirroring) and games.
- [Inputs]  
You can select the input source from the list of connected devices and jacks such as HDMI.
- [Settings]  
This category includes [Settings], [Network Settings], [Timers], and [Help].

### Hint

- By connecting the TV to the Internet, various functions such as network services become available.

## Related Topic

- [Connecting to a network using a LAN Cable](#)
- [Connecting to a network using a wireless connection](#)

C-041-100-15(1)



Copyright 2015 Sony Corporation

Television

## Using the DISCOVER button

You can use the DISCOVER button to search for content (such as TV programs, Internet content, etc.). What appears by pressing the DISCOVER button varies depending on your model/region/country.



1. Press the DISCOVER button.
  2. Move the focus up or down to select the desired category.
  3. Move the focus left or right to select the desired item.
  4.  IR Remote Control: Press the  button to choose/launch the item.
-  Touchpad Remote Control: Press the touchpad to choose/launch the item.

To change the settings of this function

1. Press the DISCOVER button.
2. Move the focus down to the [Settings] category.
3. Select the desired item to change the settings.

### Hint



- When using the Touchpad Remote Control, you can also use this function by sliding your finger up from the bottom of the touchpad (without pressing on the touchpad).

Television

## Using “Action Menu”

By pressing the ACTION MENU button, a menu appears and provides quick access to the functions that are available for the currently displayed screen, such as picture adjustment, sound adjustment, volume adjustment for the connected device (such as headphones), and display/audio change. The items in the menu differ depending on the selected screen.



1. Press the ACTION MENU button.
  2. Move the focus left or right to select the desired category.
  3. Move the focus up or down to select the desired item.
  4.  IR Remote Control: Press the  button to choose/launch the item.
-  Touchpad Remote Control: Press the touchpad to choose/launch the item.

### Hint

- When using the Touchpad Remote Control, you can also open the “Action Menu” menu by sliding your finger down from the top of the touchpad (without pressing on the touchpad).



Television

Connecting to a Network

---

[Wired LAN connection](#)



[Wireless LAN connection](#)



[Wi-Fi Direct connection](#)



[IPv6 settings](#)







Television

Using a Home Network

---

[Using a home network](#)



C-041-100-15(1)

Copyright 2015 Sony Corporation



Television

## Settings

---

[Configuring the settings related to the TV basic functions](#)



[Configuring the settings related to network connections and peripheral equipment](#)



[Configuring the settings related to system preferences](#)



[Configuring the settings related to personal information, such as security](#)





Television

## Troubleshooting

---

[Self diagnostics](#)

---



[Power symptoms](#)

---



[Picture/screen symptoms](#)

---



[Broadcast reception symptoms](#)

---



[Sound symptoms](#)

---



[Remote control symptoms](#)

---



[Touchpad Remote Control symptoms](#)

---



[3D picture/glasses symptoms \(3D models only\)](#)

---



[Connected device symptoms](#)

---



[Network/app symptoms](#)

---



[Home network symptoms](#)

---



[Bluetooth device symptoms](#)

---



[Screen mirroring symptoms](#)

---



[One-touch mirroring symptoms \(NFC models only\)](#)

---





---

C-041-100-15(1)

Copyright 2015 Sony Corporation



Television

## Watching TV programs

---

[Using the program guide](#)



[About the icons from the information banner](#)





Television

Watching in 3D (3D models only)

---

[About 3D televisions and 3D Glasses \(3D models only\)](#)



[Preparing 3D Glasses \(3D models only\)](#)



[Watching in 3D \(3D models only\)](#)

---





Television

Using SNS to enjoy programs with friends

---

[Enjoying social networking services while watching TV](#)





Television

Connecting an audio system

---

[Connecting an audio system](#)



[Playing TV sound through an audio system](#)







Television

Connecting the Wireless Subwoofer (optional)

---

[Connecting the Wireless Subwoofer \(optional\)](#)

---



[Adjusting the sound of the Wireless Subwoofer \(optional\)](#)

---





Television

Using the BRAVIA Sync function to operate another device

---

[About the BRAVIA Sync function](#)



[BRAVIA Sync-compatible devices](#)



[Using the BRAVIA Sync function](#)

---





Television

Viewing photos in 4K from compatible devices (4K models only)

---

[Viewing photos in 4K resolution \(4K models only\)](#)



[Viewing picture in 4K resolution with High-Quality \(4K models only\)](#)





Television

Connecting a BD/DVD player

---

[Connecting a BD/DVD player](#)



[Watching content from a BD/DVD player](#)





Television

Connecting a PC/digital still camera/camcorder

---

[Connecting a PC, digital still camera, or camcorder](#)



[Viewing content stored on a PC, digital still camera, or camcorder](#)





Television

Connecting a USB device

---

[Connecting a USB device](#)



[Enjoying photos/music/movies stored on a USB device](#)



[Notes on using USB devices](#)

---





Television

Using the BRAVIA Sync function to operate another device

---

[About the BRAVIA Sync function](#)



[BRAVIA Sync-compatible devices](#)



[Using the BRAVIA Sync function](#)

---





Television

Connecting an IR Blaster (IR Blaster compatible models only)

---

[Connecting an IR Blaster \(IR Blaster compatible models only\)](#)



C-041-100-15(1)

Copyright 2015 Sony Corporation





Television

## Displaying the screen of a smartphone/tablet on the TV

---

[Displaying the screen of a smartphone/tablet on the TV using an MHL cable \(MHL models only\)](#)



[Displaying the screen of a smartphone/tablet on the TV using the Screen mirroring function](#)



[Displaying the screen of a smartphone/tablet on the TV using the One-touch mirroring function \(NFC models only\)](#)





Television

Sharing photos/music/videos stored on smartphones/tablets

---

[Sharing photos/music/videos](#)





Television

Using a smartphone/tablet to operate the TV

---

[Using a smartphone/tablet installed with "TV SideView"](#)



C-041-100-15(1)

Copyright 2015 Sony Corporation

Television

## Using a smartphone/tablet installed with “TV SideView”

You can control the TV from the touch panel of a mobile device (such as a smartphone or tablet) with the “TV SideView” application installed. To use your mobile device as a TV remote control, register it to the TV as a remote device. (Registration is required only for the first time.)

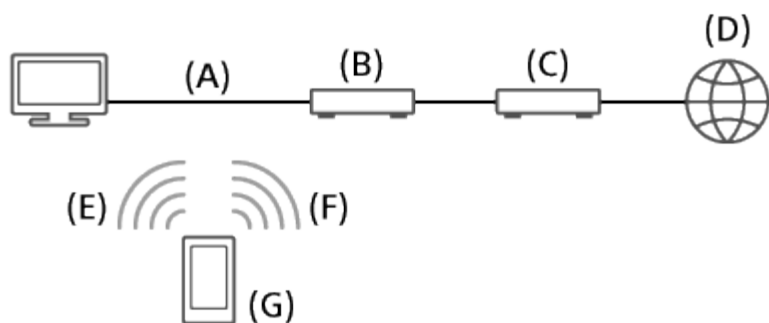

- (A) Wi-Fi or Ethernet
- (B) Router
- (C) Modem
- (D) Internet
- (E) Wi-Fi Direct
- (F) Wi-Fi
- (G) Smartphone

Available operations using the mobile device with the “TV SideView” application installed

- Powering on and controlling the TV as a remote control
- Entering text using the mobile device’s keyboard

For comprehensive information about the “TV SideView” application, refer to the following website:

<http://info.tvsideview.sony.net>

For details on how to use the “TV SideView” application, refer to the application’s help.

### Hint

- You can search and download the “TV SideView” application from here:
  - Google Play (for Android OS)
  - App Store (for iOS)

1. Connect the TV to your home network.
2. Connect the mobile device to the home network that the TV is connected to.
3. Launch the “TV SideView” application on the mobile device, then search for the TV in the home network or in the available Wi-Fi Direct devices.

4. Select the TV from the detected device list, then perform the required operation on your device.  
Mutual registration (the above steps) is required only for the first time.

Hint

- You can also connect the “TV SideView” application to the TV using Wi-Fi Direct. Press the HOME button, turn on the TV’s Wi-Fi Direct function by selecting [Settings] — [Network] — [Wi-Fi Direct] — [Wi-Fi Direct] — [On], then navigate to the [Wi-Fi Direct settings] page by selecting [Settings] — [Network] — [Wi-Fi Direct] — [Wi-Fi Direct settings].

To turn on the TV from “TV SideView” on your mobile device

1. Press the HOME button, then select [Settings] — [Network] — [Remote start] — [On].

The standby power consumption will increase if [On] is set.

Note

- Make sure that [Remote device/Renderer] is set to [On]. To confirm the setting, press the HOME button, then select [Settings] — [Network] — [Home network] — [Remote device/Renderer] — [Remote device/Renderer].
- The name and available functions of “TV SideView” are subject to change.

Related Topic

- [Connecting via Wi-Fi Direct \(without a wireless router\)](#)

Television

## Connecting to a network using a LAN Cable

A wired LAN connection allows you to access the Internet and your home network. Connect a LAN cable to your TV.

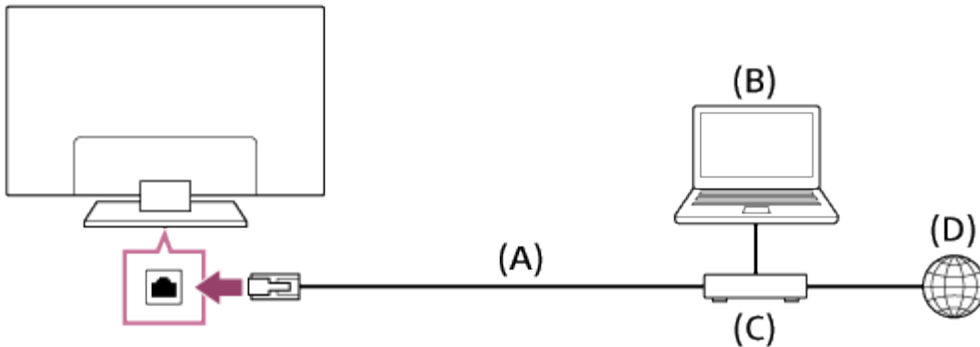

- (A) LAN cable
- (B) PC
- (C) Modem with router functions
- (D) Internet

1. Set up your LAN router.  
For details, refer to the instruction manual of your LAN router, or contact the person who set up the network (network administrator).
2. Press the HOME button, then select [Settings] — [Network] — [Network setup] — [Easy].
3. Follow the on-screen instructions to complete the setup.

### Note

- The setting items (e.g. IP address, subnet mask, DHCP) may vary depending on the Internet service provider or router. For details, refer to the instruction manuals provided by the Internet service provider or those supplied with the router. You can also contact the person who set up the network (network administrator).

Television

## Connecting to a network using a wireless connection

The built-in wireless LAN device allows you to access the Internet and enjoy the benefits of networking in a cable-free environment.

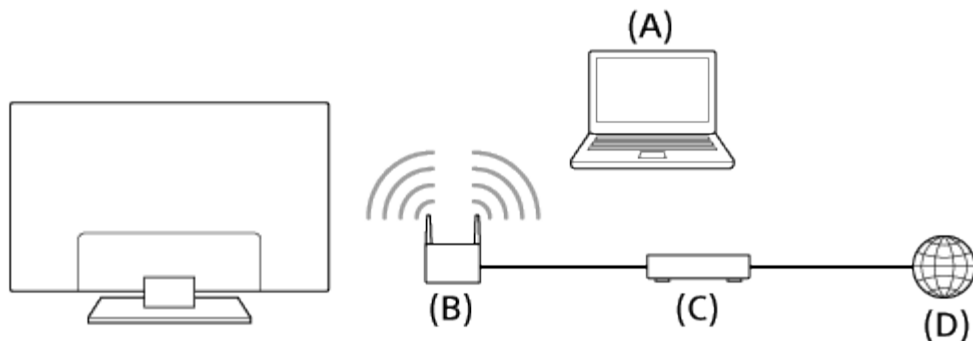

- (A) PC
- (B) Wireless router (access point)
- (C) Modem
- (D) Internet

1. Set up your wireless router (or access point).  
For details, refer to the instruction manual of your wireless router (or access point), or contact the person who set up the network (network administrator).
2. Press the HOME button, then select [Settings] — [Network] — [Network setup] — [Easy].
3. Follow the on-screen instructions to complete the setup.

## To turn off the built-in wireless LAN

Press the HOME button, then select [Settings] — [Network] — [Advanced settings] — [Built-in Wi-Fi] — [Off].

### Hint

- For smooth video streaming:
  - Change the setting of your wireless router (or access point) to 802.11n if possible. For details on how to change the setting, refer to the instruction manual of your wireless router (or access point), or contact the person who set up the network (network administrator).
  - If the above procedure does not deliver any improvement, change the setting of your wireless router (or access point) to 5GHz, which may help improve the video streaming quality.
  - The 5GHz band may not be supported depending on your region/country. If the 5GHz band is not supported, the TV can only connect to a wireless router (access point) using the 2.4GHz band.
- To use WEP security with a wireless router (or access point), select [Easy] — [Wi-Fi] — [Connect by scan list].

**Note**

- The setting items (e.g. IP address, subnet mask, DHCP) may vary depending on the Internet service provider or router. For details, refer to the instruction manuals provided by the Internet service provider or those supplied with the router. You can also contact the person who set up the network (network administrator).
- If you select the [Show password] option in the password entry screen, the exposed password may be seen by other individuals.

C-041-100-15(1)

Copyright 2015 Sony Corporation





Television

Wired LAN connection

---

[Connecting to a network using a LAN Cable](#)

---



C-041-100-15(1)

Copyright 2015 Sony Corporation



Television

Wireless LAN connection

---

[Connecting to a network using a wireless connection](#)

---



C-041-100-15(1)

Copyright 2015 Sony Corporation



Television

Wi-Fi Direct connection

---

[Connecting via Wi-Fi Direct \(without a wireless router\)](#)

---





Television

IPv6 settings

---

[Connecting to the Internet via IPv6](#)

---





Television

Using a home network

---

[Home network settings](#)



[Playing content on a PC](#)



[Playing content with the renderer function](#)





Television

Configuring the settings related to the TV basic functions

---

[Configuring the \[TV\] settings](#)

You can configure the TV settings, such as [Channels], [External inputs], [Picture & Display], [Sound], etc.

---





Television

Configuring the settings related to network connections and peripheral equipment

---

[Configuring the \[Network & Accessories\] settings](#)

You can configure the network and accessories settings, such as [Network], [Touchpad Remote Control settings], etc.

---

[Connecting a Bluetooth device](#)

---

C-041-100-15(1)

Copyright 2015 Sony Corporation



Television

Configuring the settings related to system preferences

---

[Configuring the \[System Preferences\] settings](#)

You can configure the settings to customize the TV features to suit personal preferences.

---







Television

Configuring the settings related to personal information, such as security

---

[Configuring the \[Personal\] settings](#)

You can configure the personal settings, such as [Parental lock (Broadcast)], etc.

---





Television

## Self diagnostics

---

[How to check if the TV is working properly.](#)



---

C-041-100-15(1)

Copyright 2015 Sony Corporation



Television

## Power symptoms

---

[The TV turns off automatically.](#)



[The TV turns on automatically.](#)



[After unplugging the TV and plugging it in again, the TV does not turn on even if you press the power button on the remote control or the TV.](#)



Television

## Picture/screen symptoms

---

[Picture quality is not as good as viewed at the store.](#)



[Distorted picture.](#)



[The screen flickers.](#)



[No color/Dark picture/Color is not correct/Picture is too bright](#)



[Dark screen. How to brighten the screen.](#)



[Color is not correct. How to adjust the color tone.](#)



[Screen format/wide mode changes automatically.](#)



[Suddenly the picture becomes small.](#)



[A black box appears on the screen.](#)



[Black bands appear at the edges of the screen.](#)



[Demonstration mode appears in the screen.](#)





## Television

## Broadcast reception symptoms

[Check these things first to troubleshoot your TV reception.](#)



[Ghosting or double images appear.](#)



[Only snow noise or a black picture appears on the screen.](#)



[There is picture or sound noise when viewing an analog TV channel.](#)



[Some channels are blank.](#)



[Poor reception or poor picture quality with digital broadcasts.](#)



[You cannot view digital channels.](#)



[You cannot receive or select channels.](#)



[Some digital cable channels are not displayed.](#)



[Broadcast HD formats have poor quality.](#)





Television

Sound symptoms

---

[No sound but good picture.](#)



[Audio noise.](#)



[No audio or low audio with a home theater system.](#)



[Distorted sound.](#)



[You cannot adjust the volume of the headphones.](#)





Television

## Remote control symptoms

---

[The remote control does not operate.](#)



C-041-100-15(1)

Copyright 2015 Sony Corporation



Television

## Touchpad Remote Control symptoms

---

[Touchpad Remote Control does not operate, or does not operate properly.](#)



[The batteries drain quickly.](#)





## Television

## 3D picture/glasses symptoms (3D models only)

3D pictures are not displayed. The 3D effect is weak. (3D models only)



Black bars appear on both sides of the screen when watching 3D pictures. (3D models only)



You cannot turn off 3D display while watching 3D content. (3D models only)



The message [3D signal has been detected.] automatically appears when 3D signal is detected. (3D models only)



You cannot turn the Active 3D Glasses on. (3D models only)



The LED indicator on the Active 3D Glasses blinks. (3D models only)





Television

## Connected device symptoms

---

[No picture from a connected device.](#)



[You cannot select a connected device in the Home Menu.](#)



[Certain programs on digital sources display a loss of detail.](#)



[Photo images or folders take time to display.](#)



[You cannot find a connected BRAVIA Sync HDMI device.](#)



[You cannot control a second AV receiver.](#)



[The TV does not output picture and/or sound from the MHL device. \(MHL models only\)](#)





Television

## Network/app symptoms

---

Sometimes video streaming quality is poor when using the wireless LAN.



Wireless LAN connection fails or radio reception conditions are poor.



Poor picture on Internet Videos.



Certain Internet video content displays a loss of detail.



Good picture quality but no sound on Internet video content.



Apps are inaccessible.



The TV cannot access the Internet when IPv6 is set.





Television

## Home network symptoms

---

Your TV cannot connect to the server.



A message appears stating that the TV cannot connect to your network.



Server is inaccessible.



Some media files in the USB device or server are not displayed.



The TV cannot be found by a Wi-Fi Direct device.





Television

## Bluetooth device symptoms

---

[Operation cuts out, or a device does not work.](#)





Television

## Screen mirroring symptoms

---

[What kind of devices can be connected using the Screen mirroring function?](#)



[The TV cannot connect to a Miracast device.](#)



[Video or sound sometimes cuts out.](#)



[Some pay contents cannot be played.](#)



[Screen mirroring does not work. The TV cannot be found by a Screen mirroring compatible device.](#)





Television

One-touch mirroring symptoms (NFC models only)

---

[One-touch mirroring does not work. Target device cannot be recognized. \(NFC models only\)](#)







Television

## “TV SideView” symptoms

---

The TV cannot be turned on and controlled by using the “TV SideView” application when [Remote start] is set to [On]. 

---

The TV does not appear on the “TV SideView” screen. The TV cannot be registered with the “TV SideView” application. 

---







Television

## Using the program guide

---

You can quickly find your preferred programs.

1.  IR Remote Control: Press the GUIDE button to display the digital program guide.  
  
 Touchpad Remote Control: Press the DISCOVER button, then select the program guide in the broadcast category.
2. Select the program to watch.  
The details of the program are displayed.
3. Select [View] to watch the program.

## To use optional functions

1. Press the ACTION MENU button while the program guide is displayed. Then select the desired item.



Television

## About the icons from the information banner

---

When changing the channel, an information banner appears briefly. The following icons may appear on the banner.

 : Data service (Broadcast application)

 : Radio service

 : Scrambled/Subscription service

 : Multilingual audio available

 : Closed captions/subtitles available

 : Closed captions/subtitles and/or audio available for the hearing impaired

 : Recommended minimum age for current program (from 3 to 18 years)

 : Parental lock

AD : Audio available for the visually impaired

 : Spoken subtitle audio available

 : Multi-channel audio available

Television

## About 3D televisions and 3D Glasses (3D models only)

There are two types of 3D Glasses: Passive 3D Glasses and Active 3D Glasses. Refer to a paper manual supplied with this TV to see which type of 3D Glasses it supports.

### Recommended viewing distance for a 3D image

If the viewing distance is not appropriate, a double image may appear. Sit at least 3 times the height of the screen away from the TV. It is recommended to sit directly in front of the TV.

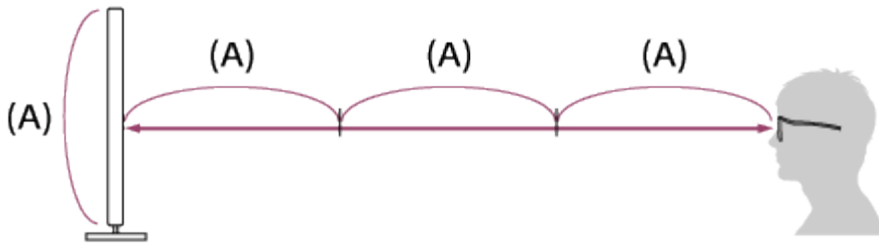

### TV and Active 3D Glasses communication range

Your viewing position needs to be within the proper range. See the following diagrams. The working distance depends on obstacles (people, metal, walls, etc.) and/or electromagnetic interference.

Overhead view

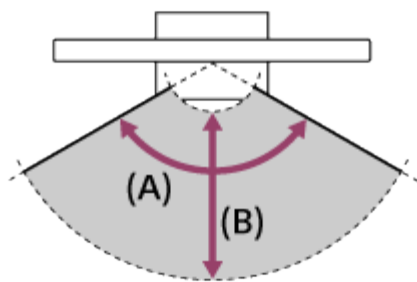

(A) 120°

(B) 1-6 m (3-20 ft.)

Side view

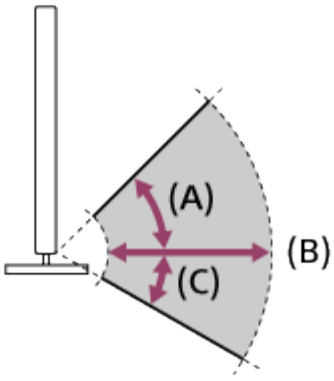

(A) 45°

(B) 1-6 m (3-20 ft.)

(C) 30°

**Note**

- Recommended viewing angle and distance may vary depending on the TV's location and room conditions.

## Maintenance of your glasses

- Wipe the glasses gently with a soft cloth.
- Stubborn stains may be removed with a cloth slightly moistened with a solution of mild soap and warm water.
- If using a chemically pretreated cloth, be sure to follow the instructions provided on the package.
- Never use strong solvents such as a thinner, alcohol, or benzene for cleaning.

C-041-100-15(1)

Copyright 2015 Sony Corporation

Television

## Preparing 3D Glasses (3D models only)

There are two types of 3D Glasses: Passive 3D Glasses and Active 3D Glasses. Refer to a paper manual supplied with this TV to see which type of 3D Glasses it supports. Then follow the instructions below to prepare the 3D Glasses.

### For Passive 3D Glasses

When Passive 3D Glasses are supplied with your TV, use them. When no glasses are supplied, purchase a pair of Passive 3D Glasses, model TDG-500P. You can watch in 3D by just putting the Passive 3D Glasses on.

### For Active 3D Glasses

When Active 3D Glasses are supplied with your TV, use them. When no glasses are supplied, purchase a pair of Active 3D Glasses, model TDG-BT500A. Before using the Active 3D Glasses for the first time, you need to register them to your TV. Follow the steps below.

1. Remove the battery's insulation sheet.

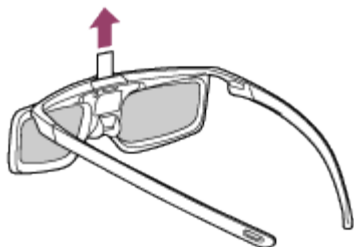

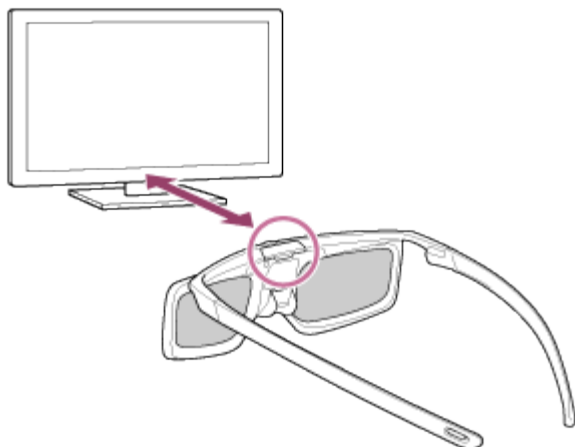

2. Turn the TV on, then hold the glasses within 50 cm (1.6 ft.) of the TV.
3. Press and hold the  (Power) button/indicator on the glasses for 2 seconds.



The Active 3D Glasses turn on and registration starts (the  (Power) button/indicator blinks green and yellow). When registration is finished, a message appears in the TV screen for 5 seconds, and the indicator lights up green for 3 seconds.

If registration fails, the Active 3D Glasses will turn off automatically. In this case, repeat the above procedure.

4. Put the Active 3D Glasses on.

From the next time, you can use the Active 3D Glasses by just turning them on. To turn them off, press and hold the  (Power) button/indicator on the glasses for 2 seconds. To turn them on again, press the  (Power) button/indicator.

Hint

- To use the Active 3D Glasses with another TV, you need to register the glasses to the TV. Perform the procedure above from Step 2.

C-041-100-15(1)

Copyright 2015 Sony Corporation

Television

## Watching in 3D (3D models only)

You can experience powerful 3D entertainment, such as stereoscopic 3D games and Blu-ray 3D Discs.

To watch in 3D, connect a 3D-compatible device directly to the TV via an authorized HIGH SPEED HDMI cable bearing the HDMI logo.



1. Prepare the 3D Glasses.
2. Display the content to watch in 3D on the TV screen.
3. Put the 3D Glasses on.  
You should now be able to watch 3D images. If no 3D effect is achieved, perform the following steps.
4. Press the HOME button, then select [Settings] — [Picture & Display] — [3D settings].
5. Select the [3D display] mode to suit the displayed content.  
Depending on the input signal or format, [3D (Side-by-Side)]/[3D (Over-Under)] may not be selectable.

### Hint

- In addition to the [3D display] mode, you can use various 3D options in [3D settings]. Press the HOME button, then select [Settings] — [Picture & Display] — [3D settings].

### Note

- The 3D effect may be less pronounced if the ambient temperature is low.
- If [Motionflow] in [Picture adjustments] is set to something other than [Off], the process to minimize screen flicker may affect the smooth movement of the picture. In such a case, press the ACTION MENU button, then select [Picture adjustments] — [Motionflow] — [Off]. (For [Motionflow] compatible models only.)

### Related Topic

- [Preparing 3D Glasses \(3D models only\)](#)

Television

## Enjoying social networking services while watching TV

---

You can view tweets that mention the program you are watching.

1. Connect to a broadband Internet connection.
2. While watching a program, press the ACTION MENU button, then select a tweet.  
The Social Viewing screen appears.

## To set a search keyword

You can set a search keyword to view tweets related to that keyword.

1. While displaying the Social Viewing screen, press the ACTION MENU button, then select [Edit keyword].
2. Select the desired search keyword.

## To change the scroll direction between horizontal and vertical

1. While displaying the Social Viewing screen, press the ACTION MENU button, select [Preferences] — [Change view], then select the desired setting.

### Hint

- You can change the settings of the search keyword. While displaying the Social Viewing screen, press the ACTION MENU button, select [Preferences], then select the desired setting.

### Related Topic

- [Connecting to a network using a LAN Cable](#)
- [Connecting to a network using a wireless connection](#)



Television

## Connecting an audio system

See the illustrations below to connect an audio system. After finishing the connection, configure the audio settings to play TV sound through the audio system (refer to the related topic link at the bottom of this page).

### To connect an ARC capable audio system using an HDMI cable

Connect an audio system (e.g., home theater system) with HDMI output to the TV, using an HDMI cable.

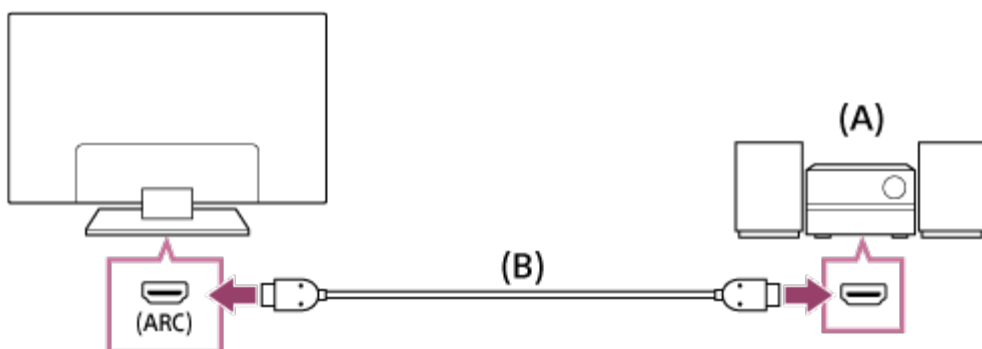

(A) Audio system

(B) HDMI cable (not supplied)\*

\* Be sure to use an authorized HIGH SPEED HDMI cable bearing the HDMI logo.

#### Hint

- When connecting a BRAVIA Sync-compatible digital audio system with Audio Return Channel (ARC) technology, connect to the HDMI IN 4 jack with an HDMI cable (the HDMI IN 4 jack carries the “ARC” mark). However, if connecting a system that is not BRAVIA Sync-compatible or Audio Return Channel capable, an additional audio connection via DIGITAL AUDIO OUT (OPTICAL) is necessary.
- See the instruction manual of the audio system for details on connecting other devices and for setup.

### To connect an audio system that is not ARC capable using an optical audio cable

Connect an audio system (e.g., home theater system) with digital input to the TV, using an optical audio cable.

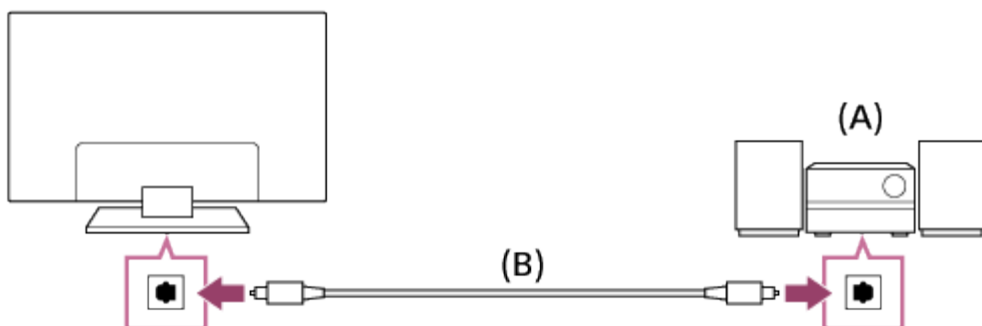

(A) Audio system

(B) Optical audio cable (not supplied)

Hint

- See the instruction manual of the audio system for details on connecting other devices and for setup.

To connect an audio system using an audio cable

Connect an audio system (e.g., amplifier) to the TV, using an audio cable.

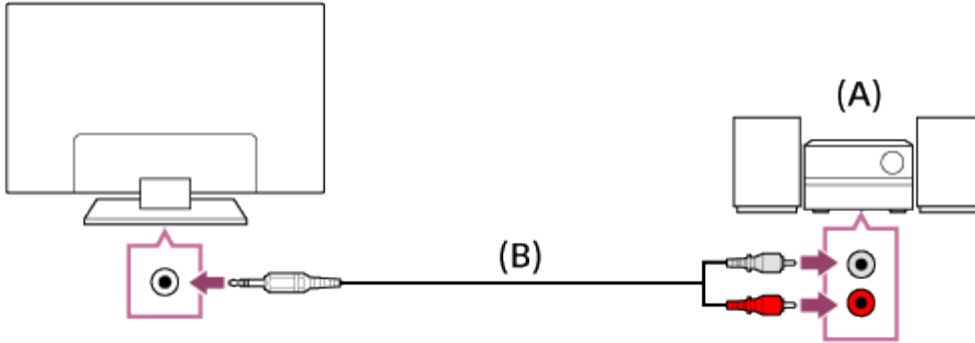

(A) Audio system

(B) Audio cable (not supplied)

Hint

- See the instruction manual of the audio system for details on connecting other devices and for the setup.

#### Related Topic

- [Playing TV sound through an audio system](#)

## Playing TV sound through an audio system

---

### When using the HDMI connection or optical audio connection

1. After making a connection, press the ACTION MENU button, then select [Speakers] — [Audio system].
2. Turn on the connected audio system, then adjust the volume.

If you connect a BRAVIA Sync-compatible device with an HDMI connection, you can operate it by simply using the TV's remote control.

#### Note

- You need to configure the [Digital audio out] settings according to your audio system. Press the HOME button, then select [Settings] — [Sound] — [Digital audio out]. (Availability of [Digital audio out] depends on the region/country.)

### When using the audio cable connection

1. After making a connection, press the HOME button, then select [Settings] — [Sound] — [Headphone/Audio out] — [Audio out (Fixed)].
2. Turn on the connected audio system, then adjust the volume.

#### Hint

- When using an external audio system, the audio out of the TV can be operated using the TV's remote control if [Headphone/Audio out] is set to [Audio out (Variable)]. Press the HOME button, then select [Settings] — [Sound] — [Headphone/Audio out] — [Audio out (Variable)].
- When connecting a subwoofer, press the HOME button, then select [Settings] — [Sound] — [Headphone/Audio out] — [Subwoofer].

Television

## Connecting the Wireless Subwoofer (optional)

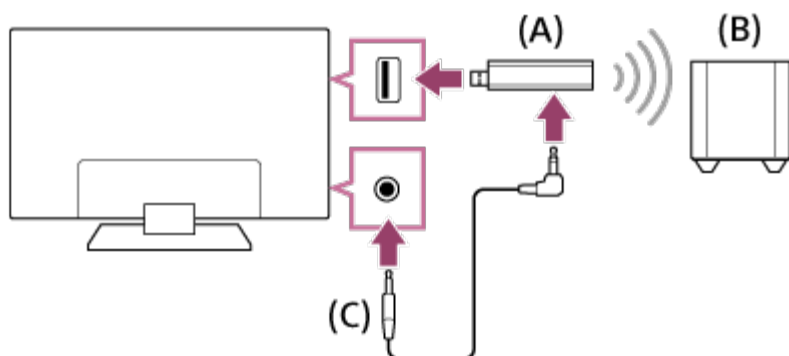

You can use the optional Wireless Subwoofer SWF-BR100 to extend the bass response of the TV's sound.



(A) Wireless Transceiver

(B) Wireless Subwoofer SWF-BR100

(C) Audio cable

1. Connect the audio cable (supplied) to the Wireless Transceiver.
2. Connect the other end of the audio cable to the AUDIO OUT/  jack of the TV.
3. Connect the Wireless Transceiver to the USB (  ) port of the TV.  
[Headphone/Audio out] is automatically set to [Subwoofer].
4. Position the Wireless Subwoofer and connect it to the AC power.  
It is recommended that the Wireless Subwoofer be placed as close as possible to the TV.

### Hint

- When the Wireless Transceiver is disconnected, [Headphone/Audio out] is automatically restored to its original setting.
- For details on how to set up the Wireless Subwoofer, refer to the instruction manual supplied with the Wireless Subwoofer.



Television

## Adjusting the sound of the Wireless Subwoofer (optional)

---

The sound settings of the Wireless Subwoofer have already been set to the recommended values for your TV. Follow the instructions below to change the settings to suit your preferences.

1. Press the HOME button, then select [Settings] — [Sound] — [Sound adjustments] — [Advanced settings] — [Sound mode related] — [Wireless Subwoofer].

### Available Options

[Wireless Subwoofer level]

Adjusts the volume level of the Wireless Subwoofer.

[Cut off frequency (50-200Hz)]

Adjusts the cut off frequency of the Wireless Subwoofer. All frequencies below the cut off frequency are output to the Wireless Subwoofer instead of the TV speakers.

[Phase]

Sets the phase polarity. Select the setting to suit your preference.

[Wireless Subwoofer sync]

Adjusts the time lag of the Wireless Subwoofer sound. If the Wireless Subwoofer sound delays, use [+]. If the sound goes ahead, use [-].

[Reset Wireless Subwoofer settings]

Resets the Wireless Subwoofer settings to their initial values.

To set the power control method of the Wireless Subwoofer

1. Press the HOME button, then select [Settings] — [Sound] — [Sound adjustments] — [Wireless Subwoofer power].

Television

## About the BRAVIA Sync function

---

If a BRAVIA Sync-compatible device (e.g., BD player, AV amplifier) is connected with an HDMI cable, or a BRAVIA Sync-compatible device (e.g., smartphone, tablet) is connected with an MHL cable (MHL models only), you can operate the device with the TV's remote control.



C-041-100-15(1)

Copyright 2015 Sony Corporation





Television

## BRAVIA Sync-compatible devices



---

Available BRAVIA Sync operations are shown below.





### BD/DVD player

- Automatically turns the BD/DVD player on and switches the input to the BD/DVD player when you select it from the Home Menu or Sync Menu.
- Automatically turns the TV on and switches the input to the connected BD/DVD player when the BD/DVD player starts to play.
- Automatically turns the connected BD/DVD player off when you turn the TV off.
- Controls menu operation (  /  /  /  buttons), playback (e.g.,  button), and channel selection of the connected BD/DVD player through the TV's remote control.

### AV amplifier

- Automatically turns the connected AV amplifier on and switches the sound output from the TV speaker to the audio system when you turn the TV on. This function is only available if you have previously used the AV amplifier to output the TV's sound.
- Automatically switches the sound output to the AV amplifier by turning the AV amplifier on when the TV is turned on.
- Automatically turns the connected AV amplifier off when you turn the TV off.
- Adjusts the volume (  +/- buttons) and mutes the sound (  button) of the connected AV amplifier through the TV's remote control.

### Video camera

- Automatically turns the TV on and switches the input to the connected video camera when the camera is turned on.
- Automatically turns the connected video camera off when you turn the TV off.
- Controls menu operation (  /  /  /  buttons), playback (e.g.,  button) of the connected video camera through the TV's remote control.

#### Note

- "BRAVIA Sync control" (BRAVIA Sync) is only available for connected BRAVIA Sync-compatible devices that have the BRAVIA Sync logo.



Television

## Using the BRAVIA Sync function

---

1. Turn on the connected device.
2. Press the HOME button, then select [Settings] — [External inputs] — [BRAVIA Sync settings] — [BRAVIA Sync control] — [On].
3. Activate BRAVIA Sync on the connected device.  
When a specific Sony BRAVIA Sync-compatible device is connected and powered on and [BRAVIA Sync control] is set to [On], BRAVIA Sync is automatically activated on that device. For details, refer to the instruction manual of the connected device.

### Available options

Available options are shown below. (Options vary depending on your region/country.)

[Device auto power off]:

If set to [Off], the connected device is not turned off automatically when the TV is turned off.

[TV auto power on]:

If set to [Off], the TV is not turned on automatically when the connected device is turned on.

[Auto input change (MHL)] (MHL models only):

If set to [On], the TV input is automatically switched to the corresponding device connected with an MHL cable.

[BRAVIA Sync device list]:

Displays the BRAVIA Sync device list.



[Device control keys]:

Allows you to set buttons to control an HDMI device/an MHL device (MHL models only).

[Charge MHL during power off] (MHL models only):

If set to [On], the connected MHL device can be also charged when the TV is in standby mode.

### To use the Sync Menu

1.  IR Remote Control: Press the SYNC MENU button, then select the desired item in the Sync Menu.  
 Touchpad Remote Control: Press the ACTION MENU button, then select [Sync Menu] — the desired item in the Sync Menu.

#### Hint

- If you press the SYNC MENU button, the promotion screen is displayed in the following cases.



- An HDMI device or an MHL device (MHL models only) is not connected.
- [BRAVIA Sync control] is set to [Off].

C-041-100-15(1)

Copyright 2015 Sony Corporation

Television

## Viewing photos in 4K resolution (4K models only)

A photo with a 4K or higher resolution can be displayed in 4K resolution (3840×2160). You can connect a digital still camera/camcorder that supports HDMI 4K output to HDMI IN of the TV to display high resolution photos stored on the camera. You can also display high resolution photos stored in connected USB devices or your home network. High resolution photos stored in a device installed with a 4K-capable application (such as PlayMemories Studio™) can also be displayed in 4K resolution.

The availability of this function depends on your region/country.

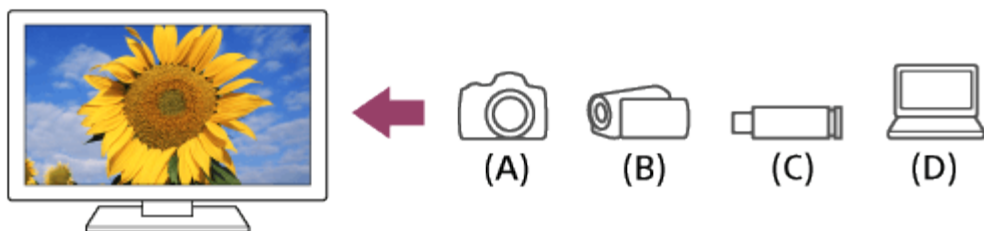

- (A) Digital still camera
- (B) Camcorder
- (C) USB device
- (D) Network device

### To view photos stored on a digital still camera/camcorder

1. Connect a digital still camera or camcorder that supports HDMI output to the HDMI IN jack of the TV, using an HDMI cable.
2. IR Remote Control: Press the INPUT button repeatedly to select the connected device.  
 Touchpad Remote Control: Press the HOME button, then select the connected device or the input that the device is connected to.
3. Set the connected device to 4K output.
4. Start playback on the connected device.

### To view photos stored on a USB device or network device in 4K resolution

1. Connect the USB device or network device to the TV.
2. Press the HOME button, then select [Album] — the USB device, server, or preset folder containing the file to play — the folder or file from the list.  
If you select a folder, select the file.

#### Note

- A 3D picture cannot be displayed.
- If you change the picture by pressing the ◀ / ▶ buttons or sliding the touchpad left/right, it may take time to display.



Television

## Viewing picture in 4K resolution with High-Quality (4K models only)

---

When you display the High-Quality 4K format\* with the HDMI input, set [HDMI signal format] in [External inputs].

### HDMI signal format

- Standard format  
Standard HDMI format for normal use.
- Enhanced format  
High-Quality HDMI format. Set only when using capable devices.

#### Note

- The picture may not be displayed properly if this setting is changed.
- Only for devices supporting High-Quality HDMI format.
- When you watch 4K picture with High-Quality\*, use a HIGH SPEED HDMI cable that supports speeds of 18 Gbps. For details on a HIGH SPEED HDMI cable that supports 18 Gbps, refer to the specifications of the cable.

\* 4K 60p 4:4:4, 4:2:2, or 4K 60p 4:2:0 10bit, etc.

Television

## Connecting a BD/DVD player

Connect a BD/DVD player to the TV.

### HDMI connection

An HDMI connection is recommended for optimum picture quality. If your BD/DVD player has an HDMI jack, connect to it using an HDMI cable.

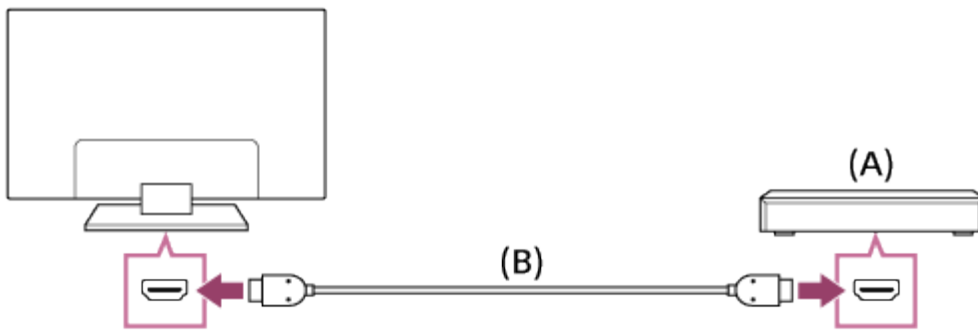

- (A) BD/DVD player
- (B) HDMI cable (not supplied)\*

\* Be sure to use an authorized HIGH SPEED HDMI cable bearing the HDMI logo.

### Component video connection

If your BD/DVD player has component video jacks, connect them to the TV using a component video cable and an audio cable.

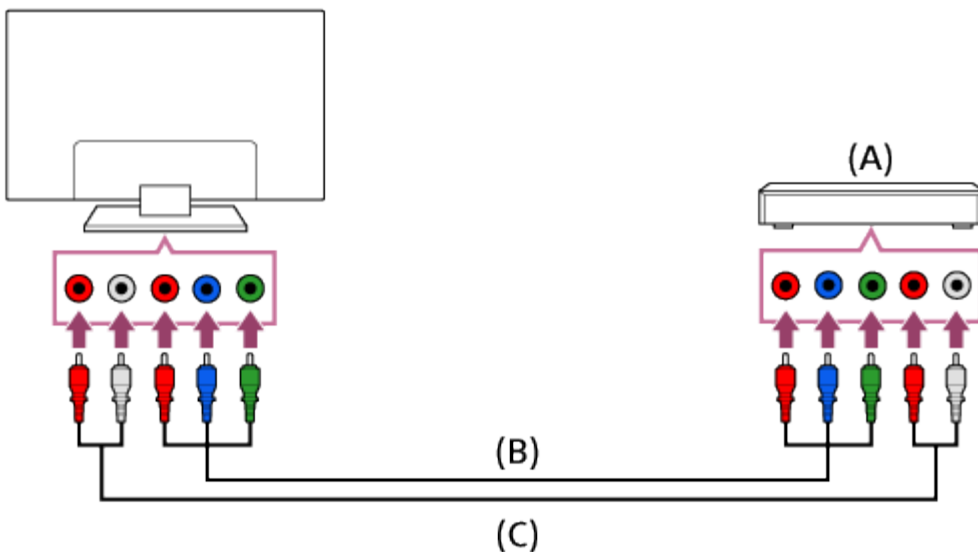

- (A) BD/DVD player

(B) Component video cable (not supplied)

(C) Audio cable (not supplied)

## Composite connection

If your BD/DVD player has composite jacks, connect to them using a composite video/audio cable.

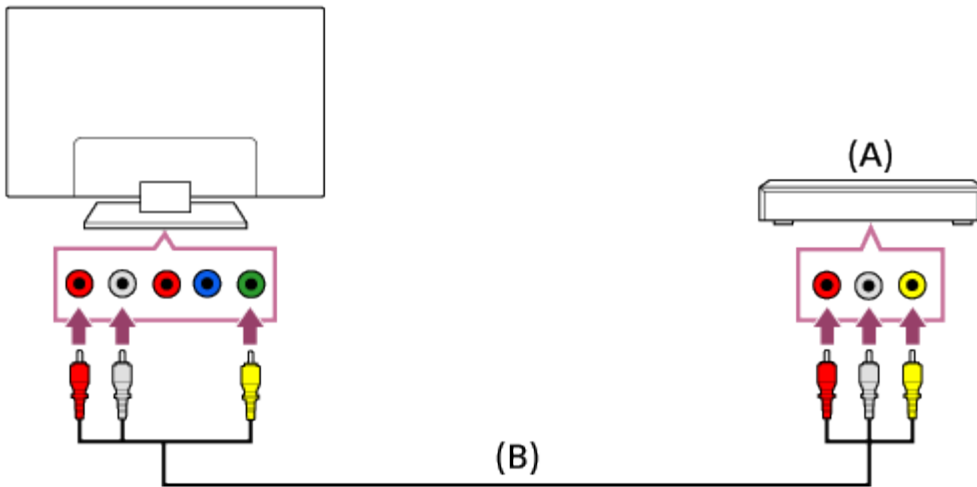

(A) BD/DVD player

(B) Composite video/audio cable (not supplied)

If using an Analog Extension Cable

Availability depends on your model/region/country.

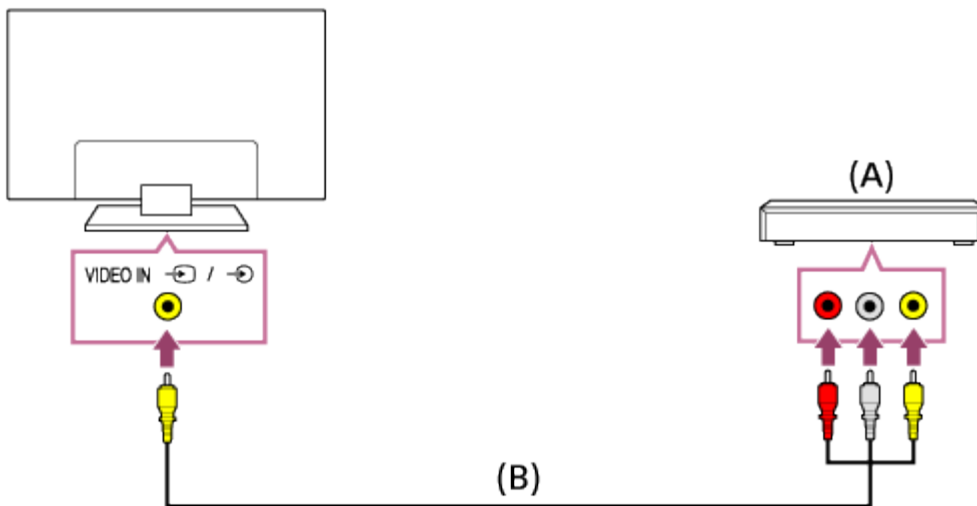

(A) BD/DVD player

(B) Analog Extension Cable (supplied)\*



\* Whether the Analog Extension Cable is supplied depends on your model/region/country.

Television

## Watching content from a BD/DVD player

---

You can watch content from a BD/DVD player connected to the TV.

1. Turn on the connected BD/DVD player.
2.  IR Remote Control: Press the INPUT button repeatedly to select the connected BD/DVD player.  
  
 Touchpad Remote Control: Press the HOME button, then select the connected BD/DVD player or the input that the BD/DVD player is connected to.
3. Start playback on the connected BD/DVD player.

### Hint

- If you connect a BRAVIA Sync-compatible device with HDMI connection, you can operate it by simply using the TV's remote control.

Television

## Connecting a PC, digital still camera, or camcorder

### To connect a PC

Connect your PC with an HDMI cable.

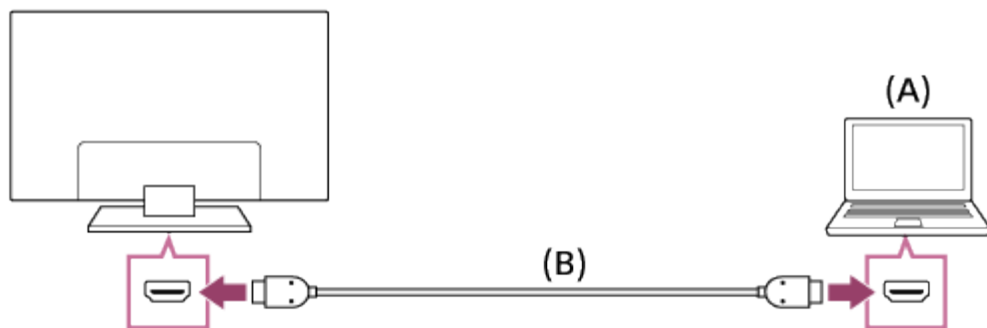

(A) PC

(B) HDMI cable (not supplied)\*

\* Be sure to use an authorized HIGH SPEED HDMI cable bearing the HDMI logo.

### Corresponding PC input signal

(Resolution, Horizontal frequency/Vertical frequency)

- 640 x 480, 31.5 kHz/60 Hz
- 800 x 600, 37.9 kHz/60 Hz
- 1024 x 768, 48.4 kHz/60 Hz
- 1152 x 864, 67.5 kHz/75 Hz (2K Full HD models or 4K models only)
- 1280 x 1024, 64.0 kHz/60 Hz (2K Full HD models or 4K models only)
- 1600 x 900, 56.0 kHz/60 Hz (2K Full HD models or 4K models only)
- 1680 x 1050, 65.3 kHz/60 Hz (2K Full HD models or 4K models only)
- 1920 x 1080, 67.5 kHz/60 Hz (2K Full HD models or 4K models only)\*

\* The 1080p timing, when applied to the HDMI input, will be treated as a video timing and not a PC timing. This will affect the [Picture & Display] settings. To view PC content, set [Wide mode] to [Full], and [Display area] to [Full pixel] (2K models) or [+1] (4K models). ([Display area] is configurable only when [Auto display area] is set to [Off].)

#### Note

- This TV does not support interlaced PC signals.
- For optimum picture quality, it is recommended that you use the signals from the above list “Corresponding PC input signal” on your PC settings.
- Depending on the connection status, the image may be blurred or smeared. In this case, change the PC’s settings, then select another input signal from the above list “Corresponding PC input signal.”
- 1920 x 1080/60 Hz output may not be available, depending on your PC. Even if 1920 x 1080/60 Hz output is selected, the actual output signal may differ. In this case, change the PC’s settings, then select another input signal from the

above list "Corresponding PC input signal."

## To connect to a digital still camera/camcorder

Connect your Sony digital still camera or camcorder using an HDMI cable. Use a cable that has an HDMI mini jack for the digital still camera/camcorder end, and a standard HDMI jack for the TV end.

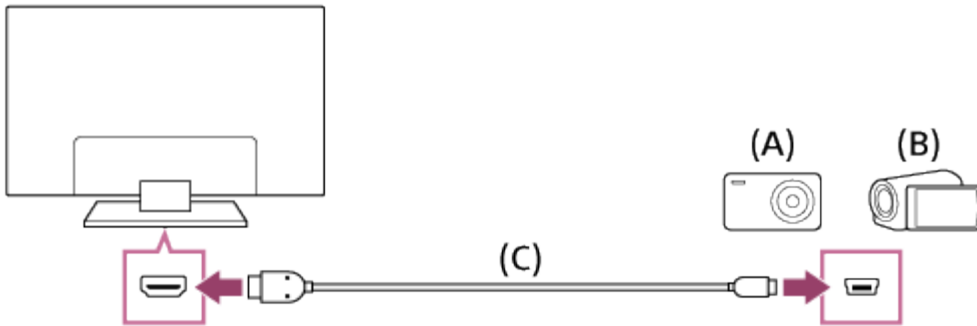

(A) Digital still camera

(B) Camcorder

(C) HDMI cable (not supplied)\*

\* Be sure to use an authorized HIGH SPEED HDMI cable bearing the HDMI logo.



Television



## Viewing content stored on a PC, digital still camera, or camcorder

---

### To view content stored on a PC

After making a connection, press the HOME button, then select the input the PC is connected to.

### To view content stored on a digital still camera/camcorder

1. After making a connection, turn on the connected digital still camera/camcorder.
2.  IR Remote Control: Press the INPUT button repeatedly to select the connected digital still camera/camcorder.
-  Touchpad Remote Control: Press the HOME button, then select the connected digital still camera/camcorder.
3. Start playback on the connected digital still camera/camcorder.

#### Hint

- If you connect a BRAVIA Sync-compatible device, you can operate it by simply using the TV's remote control. Make sure that the device is BRAVIA Sync-compatible. Some devices may not be compatible with BRAVIA Sync even though they have an HDMI jack.

#### Related Topic

- [About the BRAVIA Sync function](#)

Television

## Connecting a USB device

Connect a USB storage device to the USB port of the TV to enjoy photo, music, and video files stored on the device.

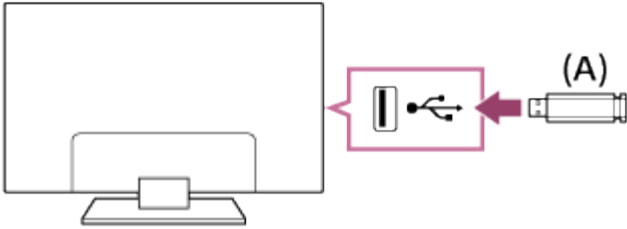

(A) USB storage device

### Related Topic

- [Enjoying photos/music/movies stored on a USB device](#)



Television

## Enjoying photos/music/movies stored on a USB device

---

You can enjoy photos/music/movies stored on a USB device on the TV screen.

1. If the USB device connected to the TV has a power switch, turn it on.
2. Press the HOME button, then select the desired item.  
Select [Album] to view photos, [Music] to play music, and [Video] to play movies.
3. Select the folder or file from the list.  
If you select a folder, select the desired file.  
Playback starts.

To check the supported file formats

When viewing the Help Guide on a computer or mobile device

Select the following link.

[➔ Jump to the list](#)



Television

## Notes on using USB devices

---

- All USB ports on the TV support Hi-Speed USB. For 4K models, one of the USB ports supports SuperSpeed (USB 3.0). USB hubs are not supported.
- The USB ports on the TV support FAT16, FAT32, exFAT, and NTFS file systems.
- When connecting a Sony digital still camera to the TV with a USB cable, USB connection settings on your camera need to be set to “Auto” or “Mass Storage” mode.
- If your digital still camera does not work with your TV, try the following:
  - Set the USB connection settings on your camera to “Mass Storage.”
  - Copy the files from the camera to a USB flash drive, then connect the drive to the TV.
- Some photos and movies may be magnified, resulting in low picture quality. Depending on the size and aspect ratio, images may not be displayed in full screen.
- It may take a long time to display a photo, depending on the file or settings.
- While accessing the USB device, do not turn off the TV or USB device, do not disconnect the USB cable, and do not remove or insert recording media. Otherwise, data stored on the USB device may be corrupted.
- Depending on the file, playback may not be possible, even when using the supported formats.
- In no event shall Sony be liable for recording failure or any damage or loss of recorded contents caused or associated with the TV’s malfunction, the USB device’s malfunction, or any other problem.

Television

## Connecting an IR Blaster (IR Blaster compatible models only)

If you connect the TV and a set-top box via HDMI cable and connect the IR Blaster to the TV, the set-top box can be operated by the TV remote control\*.

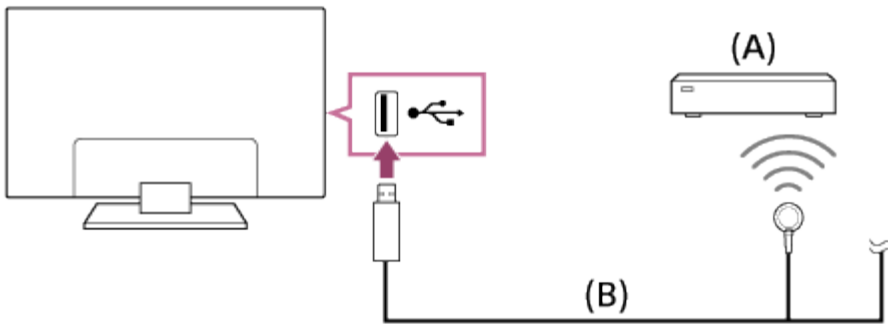

(A) Set-top box

(B) IR Blaster (supplied)\*

\* Whether the IR Blaster is supplied depends on your model/region/country.

### To set up the IR Blaster

1. Press the HOME button, then select [Settings] — [External inputs] — [IR Blaster setup].

#### Hint

- In addition to the set-top box, the IR Blaster can operate an AV receiver. To set up an AV receiver, press the HOME button, then select [Settings] — [External inputs] — [IR Blaster setup] — [AV receiver control setup].

#### Note

- Some external devices may not respond to some buttons on the “Action Menu” menu.
- If you press and hold a button on the remote control, the operation may not be transmitted. Instead, press the button repeatedly.
- Make sure that the IR Blaster is correctly set up and the IR transmitter is located near the IR receiver of the external device.
- Make sure that your TV supports the external device.

Television

## Displaying the screen of a smartphone/tablet on the TV using an MHL cable (MHL models only)

For MHL models, the **MHL** mark is located next to the HDMI IN 1/MHL port (for 2K models) or the HDMI IN 2/MHL port (for 4K models).

### To connect a smartphone/tablet with MHL output

For 2K models, connect your smartphone/tablet to the TV's HDMI IN 1/MHL port, using an MHL cable.

For 4K models, connect your smartphone/tablet to the TV's HDMI IN 2/MHL port, using an MHL cable.

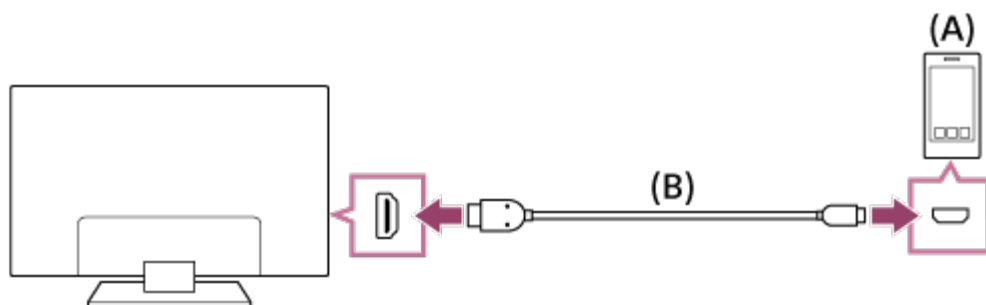

(A) MHL smartphone/tablet

(B) MHL cable (not supplied)\*

\* For 2K signals, be sure to use an authorized MHL 2 cable bearing the MHL logo.

For 4K signals, be sure to use an authorized MHL 3 cable bearing the MHL logo. If your MHL smartphone/tablet supports 4K output, use an authorized MHL 3 cable.

### To view content stored in a smartphone/tablet with MHL output

1. After making a connection, press the HOME button, then select the input the smartphone/tablet is connected to.

### To switch to the MHL input automatically

1. Press the HOME button, then select [Settings] — [External inputs] — [BRAVIA Sync settings] — [Auto input change (MHL)] — [On]. (Depending on the smartphone/tablet, input may not be switched.) If the TV is in standby mode, it will not switch automatically.

### To charge a smartphone/tablet

When the TV is on, a smartphone/tablet can be charged from the TV, using an MHL cable.

#### Hint

- When the TV is in standby mode, if [Charge MHL during power off] is set to [On], an MHL device can also be charged from the TV, using an MHL cable.

Press the HOME button, then select [Settings] — [External inputs] — [BRAVIA Sync settings] — [Charge MHL during power off] — [On].

Television

## Displaying the screen of a smartphone/tablet on the TV using the Screen mirroring function

You can display the screen of a mobile device (such as a smartphone, tablet or PC) to the TV to view photos, videos or websites.

“Screen mirroring” is a function to display the screen of a Screen mirroring compatible device on the TV by Miracast technology. A wireless router (access point) is not necessary to use this function.



- (A) Smartphone
- (B) Tablet
- (C) PC

1.  IR Remote Control: Press the INPUT button, then select [Screen mirroring].

 Touchpad Remote Control: Press the HOME button, then select [Screen mirroring].

2. Operate your Screen mirroring compatible device to connect with the TV.

When the device is connected with the TV, the screen displayed on the device will also be displayed on the TV.  
For details, refer to the instruction manual of your device.

### Note

- While the standby screen for the Screen mirroring is displayed, the wireless connection between the TV and your wireless router (access point) is disconnected, therefore communication via the Internet is stopped.

### Hint

- You can configure the advanced settings of Screen mirroring by pressing the HOME button, then selecting [Settings] — [Network] — [Wi-Fi Direct] — [Advanced settings].

Related Topic

C-041-100-15(1)

Copyright 2015 Sony Corporation



Television

Displaying the screen of a smartphone/tablet on the TV using the One-touch mirroring function (NFC models only)

By simply touching a mobile device (such as a smartphone or tablet) on the Touchpad Remote Control, you can display its screen on your large screen TV.

You can use this “One-touch mirroring” function with a One-touch mirroring compatible device (e.g., some models of Xperia).



1. Set the NFC\* setting of your mobile device to on.

\* NFC: Near Field Communication

2. Touch the NFC detection area of the mobile device to the **N** mark on the Touchpad Remote Control for about 2 seconds.

Remove the mobile device from the remote control when the device confirmation completion message appears at the bottom of the TV screen.

When the mobile device is connected with the TV, the screen displayed on the mobile device will also be displayed on the TV.

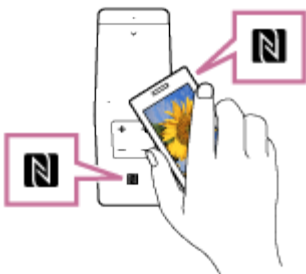

Note

- For connection with Xperia, release the screen lock on the Xperia, then touch the NFC detection area.
- For the position of the NFC detection area on the mobile device, refer to the instruction manual of the mobile device.
- If the TV cannot recognize and connect with the mobile device, try again.

Television

## Sharing photos/music/videos

Gather around the TV with your family or friends, connect your smartphones/tablets to the TV and view your favorite photos/videos on the large screen TV, or play your favorite tracks through the TV speakers.



1. Press the HOME button, then select [Photo Sharing Plus].
2. Follow the on-screen instructions to connect each smartphone/tablet to the TV.
3. Open the web browser on your smartphone/tablet and follow the on-screen instructions to access the URL shown on the TV screen.
4. Follow the on-screen instructions on your smartphone/tablet to view photos or play music/videos on the TV, or save photos/videos displayed on the TV.

### Note

- If the TV uses the 5GHz band to connect to a wireless router (or access point), the connection is disconnected when this function is started.
- Up to 10 smartphones/tablets can be connected to the TV at the same time. To connect another device when 10 devices are already connected, disconnect an unnecessary device, then connect the other device.
- The default browser for Android 2.3 or later is supported.
- The default browser for iOS is supported; however, some functions cannot be used depending on the version of your iOS.
- iOS devices cannot upload music to the TV.

Television

## Connecting via Wi-Fi Direct (without a wireless router)

The TV can be directly connected to a Wi-Fi/Wi-Fi Direct device (e.g. smartphone, PC). After connecting, you can throw content such as photos/music/videos on the device to the TV. No wireless router (or access point) is required to use this feature.



1. Press the HOME button, then select [Settings] — [Network] — [Wi-Fi Direct] — [Wi-Fi Direct] — [On].
2. Select [Wi-Fi Direct settings].
3. Select the TV name displayed on the TV screen with the Wi-Fi Direct device.  
If the device does not support Wi-Fi Direct, select the [Show Network (SSID)/Password] button.
4. Operate the Wi-Fi Direct/Wi-Fi device to connect with the TV.
5. Send content from the Wi-Fi Direct/Wi-Fi device to the TV.  
For details, refer to the instruction manual of the device.

### If the connection does not succeed

When the standby screen for the Wi-Fi Direct setting is displayed, select the [Show Network (SSID)/Password] button and follow the on-screen instructions to complete the setup.

### To connect another device

Follow the steps above to connect devices. Up to 10 devices can be connected at the same time. To connect another device when 10 devices are already connected, disconnect an unnecessary device, then connect the other device.

### To change the name of the TV shown on the connected device

Press the HOME button, then select [Settings] — [About] — [Device name].

To list connected devices/deregister devices

Press the HOME button, then select [Settings] — [Network] — [Wi-Fi Direct] — [Advanced settings] — [Show device list/Delete].

To deregister a device, select the device in the list to delete, then press the  button (or press the touchpad on the Touchpad Remote Control). Then, select [Yes] in the confirmation display.

To deregister all devices, select [All delete] in the list, then [Yes] in the confirmation display.

To change the band setting (for experts)

When your TV is not connected to any routers by wireless connection, you can select the wireless band for the Wi-Fi Direct function. Press the HOME button, then select [Settings] — [Network] — [Wi-Fi Direct] — [Advanced settings] — [Band setting].

[Auto]: Normally use this option. It automatically selects an appropriate band for the Wi-Fi Direct function.

[Auto (2.4GHz Band)]: Use this option when connecting with devices that support 2.4GHz only. This option may support more devices than other options.

[Auto (5GHz Band)]: Use this option when connecting with devices that support 5GHz. This option may improve video streaming quality.

Note that when you select this option, the TV cannot connect with devices that support 2.4GHz only.

[Manual]: Use this option to select a specific wireless channel.

#### Hint

- For information about the supported wireless band of your device, refer to the instruction manual of your device.
- The 5GHz band may not be supported depending on your region/country. If the 5GHz band is not supported, you can only use [Auto] and [Manual].

#### Note

- If the TV is connected with a wireless router (or access point) at 5GHz:
  - The 5GHz wireless connection will be disconnected when [Wi-Fi Direct settings] is selected. While the connection is disconnected, communication via Internet is stopped.
  - The connection will resume automatically after exiting from [Wi-Fi Direct settings].
- The 5GHz band may not be supported depending on your region/country.

Television

## Connecting to the Internet via IPv6

If your provider's service is compatible with IPv6, you can connect this TV to the Internet via IPv6.

Example of wireless connection:

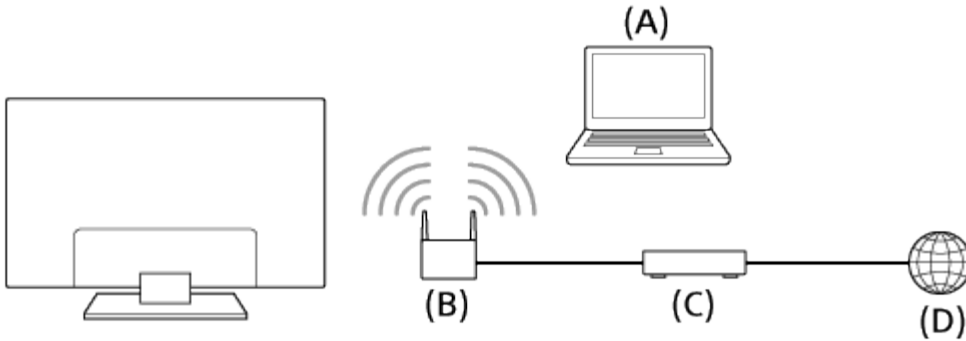

- (A) PC
- (B) Wireless router (access point) compatible with IPv6
- (C) Modem compatible with IPv6
- (D) Internet

1. Connect to a broadband Internet connection.
2. Press the HOME button, then select [Settings] — [Network] — [Advanced settings] — [IPv6 setup].
3. Follow the on-screen instructions to complete setup.

### Note

- If your network environment does not support IPv6, turn IPv6 off on the TV.

### Related Topic

- [Connecting to a network using a LAN Cable](#)
- [Connecting to a network using a wireless connection](#)

Television

## Home network settings

---

You can adjust the following home network settings.

To check the server connection

Press the HOME button, then select [Settings] — [Network] — [Home network] — [Media server troubleshooting] — follow the on-screen instructions to perform the diagnostics.

To use the remote device/renderer function

Press the HOME button, then select [Settings] — [Network] — [Home network] — [Remote device/Renderer] — the desired option.

[Remote device/Renderer]

Select [On] to enable the renderer function.

You can play photo/music/video files in a controller (e.g. digital still camera) on the TV screen by operating the device directly. Also, a mobile device (e.g. smartphone) can be used as the TV remote control via home network.

[Remote devices]

Edit the list of mobile devices registered to use as a TV remote control.

[Renderer access control]

Select [Auto access permission] to access the TV automatically when a controller accesses the TV for the first time.

Select [Custom settings] to change the access permission setting of the controller.

Select [Allow] to allow access from the controller.

Select [Block] to block access from the controller.

### Related Topic

● [Using a smartphone/tablet installed with "TV SideView"](#)

Television

## Playing content on a PC

You can play photo/music/video files stored on a server (e.g. PC) that is connected to the same home network that the TV is connected to.

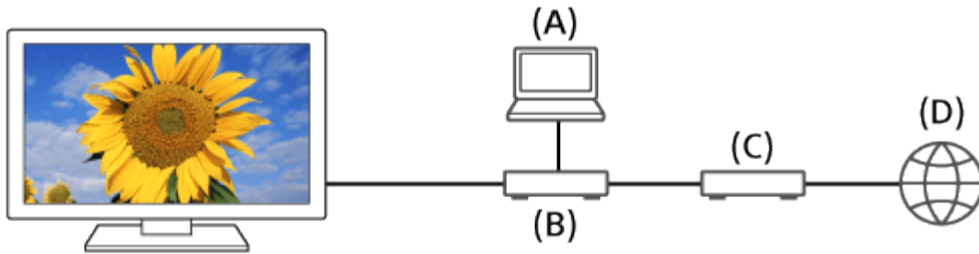

(A) PC (Server)

(B) Router

(C) Modem

(D) Internet

1. Connect the TV to your home network.
2. Press the HOME button, then select [Album], [Video], or [Music] — the server containing the file to play — the folder or file from the list.  
If you select a folder, select the desired file.  
Playback starts.

To check the supported file formats

When viewing the Help Guide on a computer or mobile device

Select the following link.

➔ [Jump to the list](#)

**Note**

- Depending on the file, playback may not be possible even when using the supported formats.

### Related Topic

- [Connecting to a network using a LAN Cable](#)
- [Connecting to a network using a wireless connection](#)

Television

## Playing content with the renderer function

You can play photo/music/video files in a controller (e.g. digital still camera) on the TV screen by operating the controller directly. The controller should also be renderer-compatible.

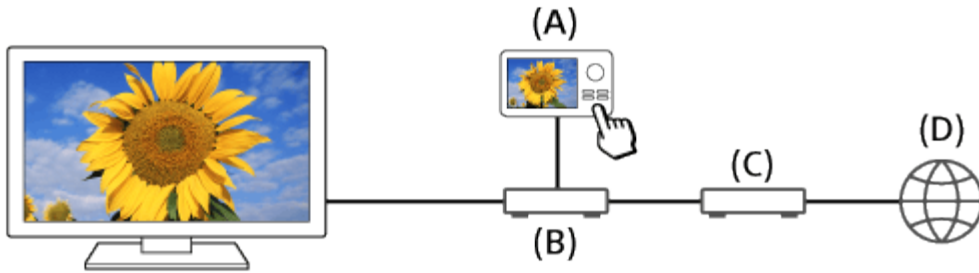

- (A) Digital still camera (Controller)
- (B) Router
- (C) Modem
- (D) Internet

1. Connect the TV to your home network.
2. Operate the controller to start playing the content on the TV screen.

### Related Topic

- [Connecting to a network using a LAN Cable](#)
- [Connecting to a network using a wireless connection](#)





Television

## Configuring the [TV] settings

---

1. Press the HOME button, then select [Settings] — [TV] — the desired option.

### Available options

#### [Channels]

Configures the settings to receive the broadcast.

#### [External inputs]

Configures the settings of external inputs.

#### [Picture & Display]

Adjusts the picture and screen settings.

#### [Sound]

Adjusts the sound settings and select speaker related options.

#### [Illumination LED]

Customizes the Illumination LED.

(The availability of this function depends on your model.)

#### [Power]

Changes the settings related to power consumption.

#### [Apps]

Changes the settings related to applications.

#### [Daydream]

Configures the settings of the screensaver.

#### [Storage & reset]

Changes the settings related to data storage.

#### [Initial setup]

Sets up the basic features such as region, channels, and network for first time use.

#### [About]

Displays the information about the TV.



Television

## Configuring the [Network & Accessories] settings

---

1. Press the HOME button, then select [Settings] — [Network & Accessories] — the desired option.

### Available options

#### [Network]

Sets up and checks the network and server connections.

#### [Google Cast]

Sets up your favorite online shows, movies, music, and more to the TV.

#### [Bluetooth settings]

Sets up for registering/deregistering Bluetooth devices.

#### [Touchpad Remote Control settings]

Sets up for pairing Touchpad Remote Control.



Television

## Connecting a Bluetooth device

---

### To pair the TV with a Bluetooth device

1. Turn the Bluetooth device on and put it in pairing mode.  
For how to put your Bluetooth device in pairing mode, refer to the instruction manual of the device.
2. Press the HOME button, then select [Settings] — [Bluetooth settings] to display the available Bluetooth device list.
3. Select the desired device from the list, then follow the on-screen instructions.  
If you are prompted to enter a passcode, refer to the instruction manual of the device.  
After the pairing is completed, the device connects to the TV.

### To connect to a paired Bluetooth device

1. Press the HOME button, then select [Settings] — [Bluetooth settings] — [Device list] to display the available Bluetooth device list.
2. Select a paired but unconnected device from the list.

### Supported Bluetooth profiles

The TV supports the following profiles:

- HID (Human Interface Device Profile)
- HOGP (HID over GATT Profile)
- 3DSP (3D Synchronization Profile)
- SPP (Serial Port Profile)



Television

## Configuring the [System Preferences] settings

---

1. Press the HOME button, then select [Settings] — [System Preferences] — the desired option.

### Available options

#### [Date & time]

Adjusts the current time.

#### [Language]

Selects the menu language.

#### [Keyboard]

Configures the settings of the on-screen keyboard.

#### [Search]

Configures the settings of the search function.

#### [Speech]

Configures the settings of speech-recognition feature.

#### [Accessibility]

Configures the settings of accessibility features and services for helping users navigate their devices more easily.

#### [Retail mode settings]

Enriches the display for shop front use by setting [Demo Mode], etc.



Television

## Configuring the [Personal] settings

---

1. Press the HOME button, then select [Settings] — [Personal] — the desired option.

### Available options

#### [Add account]

Displays the social network service accounts registered with the TV.

#### [Location]

Configures the location settings to acquire the user location

#### [Security & Restrictions]

Configures the security settings such as passwords.

#### [Parental lock (Broadcast)]

Configures the parental lock settings for broadcasts and other items.

#### [Parental lock (Streaming channels)]

Configures the parental lock settings for streaming channels.



Television

How to check if the TV is working properly.

---

- Press the HOME button, then select [Help] — [Self diagnostics].

C-041-100-15(1)

Copyright 2015 Sony Corporation



Television

The TV turns off automatically.

---

- Check if [Sleep timer] is activated or check the [Duration] setting of [Timer].
- Check if [Idle TV standby] in [Eco] is activated.

C-041-100-15(1)

Copyright 2015 Sony Corporation



Television

The TV turns on automatically.

---

- Check if [Timer] is activated.
- Set the [TV auto power on] setting of [BRAVIA Sync settings] to [Off].

C-041-100-15(1)

Copyright 2015 Sony Corporation





## Television

After unplugging the TV and plugging it in again, the TV does not turn on even if you press the power button on the remote control or the TV.

---

- When you unplug the TV and plug it in again, the TV may not be able to turn on for a while even if you press the power button on the remote control or the TV because it takes time to initialize the system. Wait for about 10 to 20 seconds, then operate it again.



Television

Picture quality is not as good as viewed at the store.

---

- Picture quality depends on the signal content.

C-041-100-15(1)

Copyright 2015 Sony Corporation



Television

## Distorted picture.

---

- Check the antenna/cable connection.
- Keep the antenna/cable away from other connecting cables.
- When installing an optional device, leave some space between the device and TV.
- Press the ACTION MENU button, then select [Picture adjustments] — [Motionflow] — [Standard] or [Off]. (For [Motionflow] compatible models only)
- Change the current setting of [CineMotion] in [Picture adjustments] to another setting.
- Set [LNA] to [Off] to improve picture reception. ([LNA] may not be available depending on the situation/region/country.)
- Make sure that the antenna is connected using a high quality 75-ohm coaxial cable.



Television

## The screen flickers.

---

- Press the ACTION MENU button, then select [Picture adjustments] — [Motionflow] — [Standard]. (For [Motionflow] compatible models only)

C-041-100-15(1)

Copyright 2015 Sony Corporation



Television

## No color/Dark picture/Color is not correct/Picture is too bright

---

- Press the ACTION MENU button, then select [Picture adjustments] to make adjustments.
- Select [Reset] in [Picture adjustments].
- If you set [Power saving] in [Eco] to [Low] or [High], the black level will be enhanced.

C-041-100-15(1)

Copyright 2015 Sony Corporation



Television

Dark screen. How to brighten the screen.

---

- Press the ACTION MENU button, select [Picture adjustments], and adjust [Brightness] or [Contrast].
- Check the [Power saving] option setting in [Eco]. If it is [Low] or [High], the screen darkens. Set [Power saving] to [Off] to brighten the screen.

C-041-100-15(1)

Copyright 2015 Sony Corporation



Television

Color is not correct. How to adjust the color tone.

---

- Press the ACTION MENU button, select [Picture adjustments], and adjust [Hue] or [Color temperature].
- To deepen the color tone, adjust [Color] or [Live Color] in [Picture adjustments].

C-041-100-15(1)

Copyright 2015 Sony Corporation



Television

## Screen format/wide mode changes automatically.

---

- When changing the channel or video input, if [Auto wide] in [Screen] is set to [On], the current [Wide mode] setting is automatically changed according to the input signal. To lock the [Wide mode] setting, set [Auto wide] to [Off].
- Check the [Auto wide] setting in [Screen].

C-041-100-15(1)

Copyright 2015 Sony Corporation





Television

Suddenly the picture becomes small.

---

- The picture becomes smaller during commercials due to the method used by the provider to broadcast content. When HD content channels switch to SD content (commercials), the picture may become small with a black border.
- [Auto wide] in [Screen] will not expand the picture while the content switches since the content information is regulated by the channel signal provider. You can manually change the [Wide mode] setting if desired, which will remain in effect until you change the channel/input or manually change the [Wide mode] setting again.

C-041-100-15(1)

Copyright 2015 Sony Corporation



Television

A black box appears on the screen.

---

- A text option is selected although no text is available. Check the [Captions]/[Broadcast Closed Captions] settings in [Accessibility]. (Option name differs depending on your region/country.) You can select a different option from the current option.

C-041-100-15(1)

Copyright 2015 Sony Corporation



Television

Black bands appear at the edges of the screen.

---

- Some wide screen programs are filmed in aspect ratios that are greater than 16:9 (this is especially common with theatrical releases). Your TV will show these programs with black bands at the top and bottom of the screen. For more details, check the documentation that came with your DVD (or contact your program provider).
- Programs in 4:3 aspect ratio will have bands on the left and right sides of the screen.
- Programs broadcasted in HD formats (720p and 1080i) with 4:3 content will commonly have black bands on the left and right sides of the screen which are added by the broadcaster.
- [Auto wide] in [Screen] will not expand the picture when the black bands on the sides of the screen are added by the broadcaster. You can manually set [Wide mode] to [Wide zoom] or [Zoom], which will remain in effect until you change the channel/input or manually change the [Wide mode] setting again.
- Some cable and satellite set-top boxes can also control the size of the picture. If you are using a set-top box, refer to the manufacturer of the set-top box for more information.



Television

Demonstration mode appears in the screen.

---

- Press the ACTION MENU button on the remote control and select [Suspend Demo]. Then, press the HOME button on the remote control, and select [Settings] — [Retail mode settings]. Set [Demo Mode] and [Picture Reset Mode] to [Off].



Television

Check these things first to troubleshoot your TV reception.

---

- Make sure that the antenna cable is firmly connected to the TV.
  - Make sure that the antenna cable is not loose or disconnected.
  - Make sure that the cable or cable connector of antenna is not damaged.

C-041-100-15(1)

Copyright 2015 Sony Corporation



Television

Ghosting or double images appear.

---

- Check cable or antenna connections.
- Check the antenna location and direction.
- Press the ACTION MENU button, then select [Picture adjustments] — [Motionflow] — [Standard] or [Off].  
(For [Motionflow] compatible models only)

C-041-100-15(1)

Copyright 2015 Sony Corporation



Television

Only snow noise or a black picture appears on the screen.

---

- Check if auto tuning is performed.
- Check if the antenna is broken or bent.
- Check if the antenna has reached the end of its serviceable life (3-5 years for normal use, 1-2 years at a seaside location).

C-041-100-15(1)

Copyright 2015 Sony Corporation



Television

There is picture or sound noise when viewing an analog TV channel.

---

- Perform [Fine tune] to obtain better picture and sound reception. (Option name differs depending on your region/country.)
- Set [Audio filter] to [Off], [Low] or [High] to improve sound for analog reception.
- Set [LNA] to [Off] to improve picture reception. ([LNA] may not be available depending on the situation/region/country.)
- Make sure that the antenna is connected using a high quality 75-ohm coaxial cable.
- Keep the antenna cable away from other connecting cables.

C-041-100-15(1)

Copyright 2015 Sony Corporation





Television

Some channels are blank.

---

- The channel is for scrambled/subscription service only. Subscribe to a pay TV service.
- The channel is used only for data (no picture or sound).
- Contact the broadcaster for transmission details.

C-041-100-15(1)

Copyright 2015 Sony Corporation



Television

## Poor reception or poor picture quality with digital broadcasts.

---

- Change the position, direction and angle of the terrestrial television antenna to maximize the antenna signal level. Make sure that the direction of the antenna is not changed unintentionally (such as by wind).
- If you are using a TV signal booster, adjust its signal gain.
- If equipment (such as a TV signal distributor) is connected between the antenna and the TV, it may affect the TV reception. Directly connect the antenna and the TV to check if the reception is improved.
- Poor weather conditions can affect satellite broadcast systems. Wait for the weather to clear. (Satellite compatible models only)

C-041-100-15(1)

Copyright 2015 Sony Corporation



Television

You cannot view digital channels.

---

- Ask a local installer if digital transmissions are provided in your area.
- Upgrade to a higher gain antenna.

C-041-100-15(1)

Copyright 2015 Sony Corporation



Television

You cannot receive or select channels.

---

- Perform [Auto program] to add receivable channels that are not present in the TV memory.
- To receive or select cable channels, make sure that the signal type in the channel settings is set to [Cable].
- To receive or select channels by antenna, make sure the signal type is set to [Antenna].

C-041-100-15(1)

Copyright 2015 Sony Corporation



Television

Some digital cable channels are not displayed.

---

- Certain cable companies have limitations on the broadcast of digital cable channels. Check with your cable company for more information.
- The digital cable channel may be set to [Hidden] in [Show/Hide channels].

C-041-100-15(1)

Copyright 2015 Sony Corporation



Television

## Broadcast HD formats have poor quality.

---

- Content and signal quality are regulated by the signal provider. Many HD channels and content are actually upscaled versions of standard-definition broadcasts. The picture is affected by the quality of the signal received, which varies between channel and program.

C-041-100-15(1)

Copyright 2015 Sony Corporation



Television

## No sound but good picture.

---

- Check the volume control.
- Press MUTING or VOL + button to cancel muting.
- Press the ACTION MENU button, then select [Speakers] — [TV speakers].  
If it is set to [Audio system], the TV speakers only output key tones and system sound.
- When using HDMI input with Super Audio CD or DVD-Audio, DIGITAL AUDIO OUT (OPTICAL) may not provide an audio signal.

C-041-100-15(1)

Copyright 2015 Sony Corporation



Television

## Audio noise.

---

- Make sure that the antenna is connected using a high quality 75-ohm coaxial cable.
- Keep the antenna cable away from other connecting cables.
- To avoid TV interference, make sure to use an undamaged antenna cable.

C-041-100-15(1)

Copyright 2015 Sony Corporation





Television

No audio or low audio with a home theater system.

---

- Press the ACTION MENU button, then select [Speakers] — [Audio system].
- Set [Headphone/Audio out] to [Audio out (Fixed)] in the [Sound] setting.
- If [Speakers] is set to [TV speakers] and [Hi-Res upscaling (DSEE HX)] is set to [Auto], DIGITAL AUDIO OUT (OPTICAL) is muted.
- Set [Digital audio out volume] to Max in the [Sound] setting.

C-041-100-15(1)

Copyright 2015 Sony Corporation



Television

## Distorted sound.

---

- Check the antenna/cable connection.
- Keep the antenna/cable away from other connecting cables.
- Keep the TV away from electrical noise sources such as cars, hair-dryers, Wi-Fi units, mobile phones, or optical devices.
- When installing an optional device, leave some space between the device and TV.
- Set [Audio filter] to [Low] or [High] to improve sound for analog reception. ([Audio filter] may not be available depending on your region/country.)

C-041-100-15(1)

Copyright 2015 Sony Corporation



Television

You cannot adjust the volume of the headphones.

---

- Press the ACTION MENU button, select [Headphone volume], then adjust the volume.

C-041-100-15(1)



Copyright 2015 Sony Corporation



Television

## The remote control does not operate.

---

- Press a button on the TV to determine if the problem is with the remote control or not.
- Check that the orientation of each battery matches the positive (+) and negative (-) symbols in the battery compartment.
- Battery power may be low. Replace the batteries with new ones.
- There may be poor contact between the battery and the remote control. Remove the batteries, then insert them again.
- Point the remote control at the remote control sensor located at the front of the TV.
- Keep the remote control sensor area clear from obstacles.
- Fluorescent light can interfere with remote control operation; try turning off any fluorescent light.
- When you unplug the TV and plug it in again, the TV may not be able to turn on for a while even if you press the power button on the remote control or the TV because it takes time to initialize the system. Wait for about 10 to 20 seconds, then operate it again.
- When your voice is not being recognized, make sure to activate the  button on the remote control with the  button, or register the remote control with the  button to your TV. To confirm these settings, press the HOME button, then select [Settings] — Remote control settings.

If viewing the Help Guide (Online) on the TV, select [Switch to Built-in] at the upper right of the screen. The link that leads to the setting screen will appear.

## Touchpad Remote Control does not operate, or does not operate properly.

- Replace the batteries. Push the release button and remove the cover.

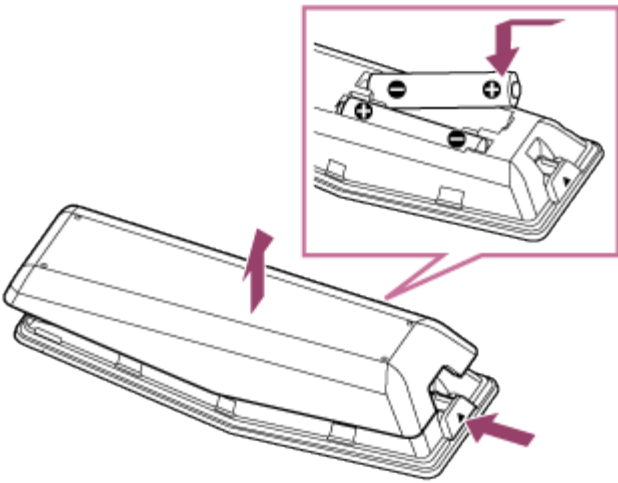

- There may be poor contact between the battery and the remote control. Remove the batteries, then insert them again.
- Re-pair the Touchpad Remote Control. Press the HOME button, then select [Settings] — [Touchpad Remote Control settings] — [Pair Touchpad Remote Control].
- The Touchpad Remote Control uses the 2.4GHz band, therefore communication speed may deteriorate or cut out occasionally due to wireless LAN interference.  
If household electric appliances (e.g. microwaves or smartphones) are placed nearby, radio wave interference is more likely to happen.
- The TV or Touchpad Remote Control may not work on a metal rack due to wireless communication interference.
- The Touchpad Remote Control can control only the last paired TV.
- Only one Touchpad Remote Control can be paired to the TV.
- It is recommended to use the Touchpad Remote Control within 7 m (23 ft.) of the TV.
- When you unplug the TV and plug it in again, the TV may not be able to turn on for a while even if you press the power button on the remote control or the TV because it takes time to initialize the system. Wait for about 10 to 20 seconds, then operate it again.



Television

## The batteries drain quickly.

---

- If you keep waving your NFC compatible device over the NFC touch point of the remote control, it will increase battery drainage of the remote control and/or the device (NFC models only).
- Do not leave the Touchpad Remote Control faced down.

C-041-100-15(1)

Copyright 2015 Sony Corporation



Television

3D pictures are not displayed. The 3D effect is weak. (3D models only)

---

- If two pictures are displayed side-by-side, press the HOME button, then select [Settings] — [Picture & Display] — [3D settings] — [3D display] — [3D (Side-by-Side)].  
If two pictures are displayed one above the other, press the HOME button, then select [Settings] — [Picture & Display] — [3D settings] — [3D display] — [3D (Over-Under)].
- If the [3D display] screen appears and 3D pictures are not displayed, turn off the device that plays 3D content and turn it on again.
- Perceived 3D effect may vary from person to person.

For Active 3D Glasses models

- Be sure that there are no obstacles between the TV and the Active 3D Glasses.
- Replace the battery in the Active 3D Glasses.
- Be sure that the Active 3D Glasses are powered on.
- It is necessary to register your Active 3D Glasses to the TV before use. To use the glasses with another TV, it is necessary to re-register. Turn off the glasses before re-registering.
- Wireless devices or microwave ovens may affect the communication between the 3D Glasses and the TV as the TV uses the 2.4GHz band. In this case, try to register again.
- If a device that is not 3D-compatible (such as a home theater system) is connected between the TV and a 3D-compatible device, the TV will not display 3D pictures. Connect the 3D-compatible device directly to the TV via an authorized HIGH SPEED HDMI cable bearing the HDMI logo.

For 4K models

- 3D signal of 4K cannot be displayed.
- For Passive 3D Glasses models, view the TV from the front on. The 3D effect may be less pronounced depending on the viewing position. Adjust the viewing angle to the screen.



Television

Black bars appear on both sides of the screen when watching 3D pictures. (3D models only)

---

- Black bars appear on both sides of the screen in order to process 3D signals when adjusting the depth of 3D pictures in [3D depth adjustment].

C-041-100-15(1)

Copyright 2015 Sony Corporation





Television

You cannot turn off 3D display while watching 3D content. (3D models only)

---

- For 3D content displayed with the 3D signal, 3D display cannot be turned off on your TV. Turn 3D settings off on the connected device (such as a BD player).

C-041-100-15(1)

Copyright 2015 Sony Corporation



Television

The message [3D signal has been detected.] automatically appears when 3D signal is detected. (3D models only)

---

- Deactivate the [3D signal notification] setting. Press the HOME button, then select [Settings] — [Picture & Display] — [3D settings] — [3D signal notification] — [Off].

C-041-100-15(1)

Copyright 2015 Sony Corporation

Television

You cannot turn the Active 3D Glasses on. (3D models only)

- Replace the battery. (Applies only to TDG-BT400A/BT500A.)

Press the unlock button with the tip of a pen, etc., and take out the battery case, then replace the battery with a new one. After that, be sure to lock the battery case again.

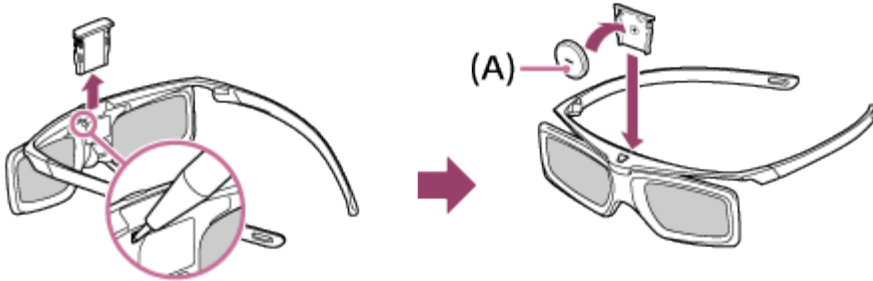

(A) CR2025 (-) side

C-041-100-15(1)

Copyright 2015 Sony Corporation

Television

The LED indicator on the Active 3D Glasses blinks. (3D models only)

---

- Lights up for 3 seconds: Indicates when turning on the glasses.

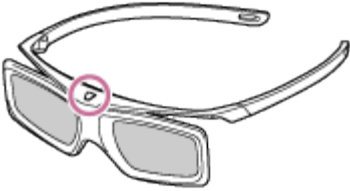

- Blinks every 2 seconds: Indicates the glasses are powered on.
- Blinks 3 times: Indicates the glasses have been powered off.
- Blinks green and yellow alternately: Indicates the glasses have started the registration process.
- Blinks 3 times every 2 seconds: Indicates the battery capacity is almost running out. Replace the battery.

C-041-100-15(1)



Copyright 2015 Sony Corporation



Television

## No picture from a connected device.

---

- Turn the connected device on.
- Check the cable connection between the device and TV.
-  IR Remote Control : Press the INPUT button to display the list of inputs, then select the desired input.
-  Touchpad Remote Control : Press the HOME button, then select the desired input.
- Correctly insert the USB device.
- Make sure that the USB device has been properly formatted.
- Operation is not guaranteed for all USB devices. Also, operations differ depending on the USB device features or the video files being played.



Television

You cannot select a connected device in the Home Menu.

---

- Check the cable connection.

C-041-100-15(1)

Copyright 2015 Sony Corporation



Television

Certain programs on digital sources display a loss of detail.

---

- Less detail than usual or artifacts (small blocks, dots or pixelation) may appear on the screen, due to the digital compression of the source content used by certain digital broadcasts and DVDs. The degree of visible artifacts depends on the clarity and resolution of the TV.

C-041-100-15(1)

Copyright 2015 Sony Corporation



Television

### Photo images or folders take time to display.

---

- Depending on the image dimension, file size, and number of files in a folder, some photo images or folders take time to display.
- Each time a USB device is connected to the TV, it may take up to a couple of minutes for the photos to display.

C-041-100-15(1)

Copyright 2015 Sony Corporation





Television

You cannot find a connected BRAVIA Sync HDMI device.

---

- Check that your device is BRAVIA Sync-compatible.
- Make sure that [Control for HDMI] is set up on the BRAVIA Sync-compatible device and [BRAVIA Sync control] is set up on the TV.

C-041-100-15(1)

Copyright 2015 Sony Corporation



Television

You cannot control a second AV receiver.

---

- Only one BRAVIA Sync-compatible AV receiver can be used.

C-041-100-15(1)

Copyright 2015 Sony Corporation



Television

The TV does not output picture and/or sound from the MHL device. (MHL models only)

---

- Disconnect the MHL cable, then reconnect it. Or turn the MHL device off, then turn on again and release the screen lock of the device.

C-041-100-15(1)

Copyright 2015 Sony Corporation



Television

Sometimes video streaming quality is poor when using the wireless LAN.

---

- The wireless network connection quality varies depending on the distance or obstacles (e.g. wall) between the TV and the wireless router (access point), environmental interference, and the quality of the wireless router (access point). In this case, use a wired connection for the Internet, or try the 5GHz band.
- The 5GHz band may not be supported depending on your region/country. If the 5GHz band is not supported, the TV can only connect to a wireless router (access point) using the 2.4GHz band.

C-041-100-15(1)

Copyright 2015 Sony Corporation



Television

Wireless LAN connection fails or radio reception conditions are poor.

---

- Check the installation location of the TV and wireless router (access point). Signal condition may be affected by the following :
  - Other wireless devices, microwaves, fluorescent lights, etc., are placed nearby.
  - There are floors or walls between the wireless router (access point) and TV.

If the problem persists even after checking the above, try using a wired LAN connection.



Television

## Poor picture on Internet Videos.

---

- Quality depends on the original video provided by the video content provider and your connection bandwidth.

C-041-100-15(1)

Copyright 2015 Sony Corporation



Television

Certain Internet video content displays a loss of detail.

---

- Video quality and picture size depend on broadband speed and delivery by video content providers.

C-041-100-15(1)

Copyright 2015 Sony Corporation



Television

Good picture quality but no sound on Internet video content.

---

- Quality depends on the original content provided by the video content provider and your connection bandwidth.
- Due to the nature of Internet video, not all videos will contain sound.

C-041-100-15(1)

Copyright 2015 Sony Corporation





Television

## Apps are inaccessible.

---

- Check that the LAN cable or AC power cord of the router/modem\* has been connected properly.
  - \* Your router/modem must be set in advance to connect to the Internet. Contact your Internet service provider for router/modem settings.
- Try using apps later. The app content provider's server may be out of service.

C-041-100-15(1)

Copyright 2015 Sony Corporation



Television

The TV cannot access the Internet when IPv6 is set.

---

- IPv6 may not be available, in which case set IPv6 to off.

C-041-100-15(1)

Copyright 2015 Sony Corporation



Television

Your TV cannot connect to the server.

---

- Check the LAN cable or wireless connection to your server and your TV.
- Check if your network is properly configured on your TV.

C-041-100-15(1)

Copyright 2015 Sony Corporation



Television

A message appears stating that the TV cannot connect to your network.

---

- Check the current network settings. Press the HOME button, then select [Settings] — [Network] — [Advanced settings] — [Network status]. Check your network connections and/or server's instruction manual for connection information, or contact the person who set up the network (network administrator).
- Reconfigure your network settings by pressing the HOME button, then select [Settings] — [Network] — [Network setup].
- If the LAN cable is connected to an active server and the TV has acquired an IP address, check your server's connections and configurations. Press the HOME button, then select [Settings] — [Network] — [Advanced settings] — [Network status].



Television

### Server is inaccessible.

---

- Check your LAN cable/wireless connection or your server. The TV may have lost connection with the server.
- Perform [Media server troubleshooting] to check if your media server is properly communicating with the TV. Press the HOME button, then select [Settings] — [Network] — [Home network] — [Media server troubleshooting].

C-041-100-15(1)

Copyright 2015 Sony Corporation



Television

Some media files in the USB device or server are not displayed.

---

- Unsupported files may not be displayed.
- All the folders/files may not be displayed depending on the system status.

C-041-100-15(1)

Copyright 2015 Sony Corporation



Television

The TV cannot be found by a Wi-Fi Direct device.

---

- Set [Wi-Fi Direct] to [On]. Press the HOME button, then select [Settings] — [Network] — [Wi-Fi Direct] — [Wi-Fi Direct] — [On].
- If the TV cannot be found even though [Wi-Fi Direct] is [On], set [Band setting] to [Auto (2.4GHz Band)]. Press the HOME button, then select [Settings] — [Network] — [Wi-Fi Direct] — [Advanced settings] — [Band setting] — [Auto (2.4GHz Band)].



Television

Operation cuts out, or a device does not work.

---

- Check if the device is turned on.
- Replace the batteries of the device.
- Re-register the device.
- Bluetooth devices use the 2.4GHz band, therefore communication speed may deteriorate or cut out occasionally due to wireless LAN interference.  
If household electric appliances (e.g. microwaves or smartphones) are placed nearby, radio wave interference is more likely to happen.
- The TV or device may not work on a metal rack due to wireless communication interference.
- For usable communication distances between the TV and other devices, refer to the instruction manuals of the devices.
- When multiple Bluetooth devices are connected to the TV, the quality of Bluetooth communication may deteriorate.





Television

## What kind of devices can be connected using the Screen mirroring function?

---

- Wi-Fi enabled devices, such as smartphones and tablets, that support Miracast can be used to enjoy Screen mirroring on your BRAVIA TV. Refer to the instruction manual of your Wi-Fi device to find out if it supports Miracast. BRAVIA TV complies with the Miracast specification, but does not guarantee a successful connection with all devices.

C-041-100-15(1)

Copyright 2015 Sony Corporation



Television

The TV cannot connect to a Miracast device.

---

- If connecting a Miracast device (e.g. note PC) fails, press the HOME button, then select [Screen mirroring] to show the standby screen for the Screen mirroring function and try to connect again.

C-041-100-15(1)

Copyright 2015 Sony Corporation



Television

Video or sound sometimes cuts out.

---

- Devices emitting radio waves, such as other wireless LAN devices or microwave ovens, may interfere with the Screen mirroring function using wireless LAN. Keep the TV or Sony Screen mirroring compatible devices (e.g. some models of Xperia) away from such devices, or turn them off if possible.
- Communication speed may change according to the distance or obstacles between devices, device configuration, radio wave condition, line congestion or the device you use. Communication may cut out due to the radio wave condition.

C-041-100-15(1)

Copyright 2015 Sony Corporation



Television

Some pay contents cannot be played.

---

- The source device needs to meet HDCP (High-bandwidth Digital Content Protection) 2.0/2.1/2.2 standards.  
Some pay contents may not be displayed via a source device which does not meet HDCP 2.0/2.1/2.2 standards.

C-041-100-15(1)

Copyright 2015 Sony Corporation



Television

Screen mirroring does not work. The TV cannot be found by a Screen mirroring compatible device.

---

- If you are using Screen mirroring with another device, turn off Screen mirroring first and try again.
- If your device does not support 5GHz and you set the [Band setting] option to [Auto (5GHz Band)], try changing it to [Auto].
- Press the HOME button, then select [Screen mirroring] to show the standby screen for Screen mirroring and try again.

C-041-100-15(1)

Copyright 2015 Sony Corporation



Television

One-touch mirroring does not work. Target device cannot be recognized. (NFC models only)

---

- Make sure that the NFC function of the One-touch mirroring compatible device is turned on.
- For connection with a One-touch mirroring compatible Xperia, the TV cannot connect with the Xperia when its screen is locked. Release the screen lock, then touch.
- Determine the position of the NFC detection area on the One-touch mirroring compatible device, then try touching again. For the position of the NFC detection area, refer to the instruction manual of the compatible device.
- Move the compatible device away from the Touchpad Remote Control, then try touching again.
- If you are using Screen mirroring with another device, turn off Screen mirroring first and try again.
- If your device does not support 5GHz and you set the [Band setting] option to [Auto (5GHz Band)], try changing it to [Auto].
- Press the HOME button, select [Screen mirroring] to open the standby screen for Screen mirroring, then try again.
- Check whether your device supports One-touch mirroring. Even if you touch an incompatible device, the TV may show some reaction but cannot start Screen mirroring.
- It is necessary to pair the Touchpad Remote Control to the TV before use.
- Set the NFC setting of the compatible device to on.



## Television

The TV cannot be turned on and controlled by using the “TV SideView” application when [Remote start] is set to [On].

---

- When devices that cause radio wave interference (microwave ovens, cordless phones, etc.) are placed nearby, the “TV SideView” function may not work. In this case, keep such devices away from the wireless router (access point) or TV, or turn them off.
- In the following cases, the “TV SideView” function may not work. Turn on the TV and re-connect to the wireless router (access point).
  - Turn on/off the wireless router (access point) power during TV standby mode
  - Reset the wireless router (access point) during TV standby mode
  - Change the wireless router (access point) channel during TV standby mode
- The “TV SideView” function may not work with business-use wireless routers (access points) that require reconnection periodically.
- The “TV SideView” function may not work depending on the settings of the wireless router (access point) (e.g. Multi SSID and Power saving mode).
- If Wi-Fi Direct is used to connect the “TV SideView” application to the TV, the TV may not be turned on from standby mode depending on your smartphone/tablet.
- The TV should be in the power-on or standby mode. Do not turn off the TV by disconnecting its AC power cord.
- Check the following has been set for your TV.

When the wireless router (access point) and TV are connected with wireless LAN

- Built-in wireless LAN model TV is used
- [Built-in Wi-Fi] under [Advanced settings] is set to [On]
- [Remote start] under [Network] is set to [On]
- TV is connected to the wireless router (access point)

When the wireless router (access point) and TV are connected with wired LAN

- [Remote start] under [Network] is set to [On]



## Television

The TV does not appear on the “TV SideView” screen. The TV cannot be registered with the “TV SideView” application.

---

- Make sure that the TV is turned on.
- Make sure that the TV and your smartphone/tablet have joined the same home network.  
(However, when connecting via Wi-Fi Direct, a home network connection is not necessary.)
- The maximum number of registration devices may have been reached. Delete unnecessary registrations from [Remote devices] before registering another smartphone/tablet.
- For detailed information, refer to the following website:  
<http://info.tvsideview.sony.net/faq/>



## Supported Codec for Home Network / USB device

[Photo](#) | [Music](#) | [Video \(for 2K models\)](#) | [Video \(for 4K models\)](#)

[Supported Audio Codec Sampling Rate in Video Content](#) | [External Subtitle](#)

## Photo

File Format: JPEG

## ● JPEG

Extension \*.jpg / \*.jpe / \*.jpeg

## Music

Container: - / mp4 / 3gpp / Asf

## ● -

Extension -

Description LPCM

Supported Sampling Rate 32k / 44.1k / 48k

Extension \*.mp3

Description MP1L1 / MP1L2 / Mp1L3 / Mp2L1 / Mp2L2

Supported Sampling Rate 32k / 44.1k / 48k

Description Mp2L3

Supported Sampling Rate 16k / 22.05k / 24k

Description MP2.5L3

Supported Sampling Rate 8k / 11.025k / 12k

Extension \*.wav

Description WAV

Supported Sampling Rate 32k / 44.1k / 48k / 88.2k / 96k / 176.4k / 192k

Extension \*.flac

Description FLAC

Supported Sampling Rate 16k / 22.05k / 32k / 44.1k / 48k / 88.2k / 96k / 176.4k / 192k

## ● mp4

Extension \*.mp4 / \*.m4a

Description AAC-LC

Supported Sampling Rate 16k / 22.05k / 24k / 32k / 44.1k / 48k

---

Description HE-AAC v1 / v2

Supported Sampling Rate 24k / 32k / 44.1k / 48k

---

- 3gpp

Extension \*.3gp / \*.3g2

Description AAC-LC

Supported Sampling Rate 16k / 22.05k / 24k / 32k / 44.1k / 48k

---

Description HE-AAC v1 / v2

Supported Sampling Rate 24k / 32k / 44.1k / 48k

---

- Asf

Extension \*.wma

Description WMA9 Standard

Supported Sampling Rate 8k / 11.025k / 16k / 22.05k / 32k / 44.1k / 48k

---

## Video (for 2K models)

Container: MPEG1 / MPEG2PS / MPEG2TS / MP4 / avi / Asf / MKV / 3gpp / MOV / WebM

- MPEG1

Extension \*.mpg / \*.mpe / \*.mpeg

Video Codec (Profile@Level) MPEG1

Audio Codec MPEG1L2

Supported Subtitle Type External

Supported Maximum Resolution 1920x1080

Supported Minimum Resolution QCIF (176x144)

Supported Maximum Frame Rate 1920x1080@30fps / 1280x720@60fps

---

- MPEG2PS

Extension \*.mpg / \*.mpe / \*.mpeg

Video Codec (Profile@Level) MPEG2 MP@HL, MP@H14L, MP@ML

Audio Codec MPEG1L1 / MPEG1L2 / LPCM / AC3

Supported Subtitle Type External

Supported Maximum Resolution 1920x1080

Supported Minimum Resolution QCIF (176x144)

Supported Maximum Frame Rate 1920x1080@30fps / 1280x720@60fps

---

- MPEG2TS

---

Extension \*.m2t

Video Codec (Profile@Level) MPEG2 MP@HL, MP@H14L, MP@ML

Audio Codec MPEG1L1 / MPEG1L2 / AAC-LC / HE-AAC v1 / HE-AAC v2 / AC3 / E-AC3

Supported Subtitle Type -

Supported Maximum Resolution 1920x1080

Supported Minimum Resolution QCIF (176x144)

Supported Maximum Frame Rate 1920x1080@30fps / 1280x720@60fps

---

Extension \*.m2ts / \*.mts

Video Codec (Profile@Level) AVC / H.264 BP@L3, MP@L4.2, HP@L4.2

Audio Codec MPEG1L1 / MPEG1L2 / AAC-LC / HE-AAC v1 / HE-AAC v2 / AC3 / E-AC3

Supported Subtitle Type -

Supported Maximum Resolution 1920x1080

Supported Minimum Resolution QCIF (176x144)

Supported Maximum Frame Rate 1920x1080@60fps

---

- MP4

---

Extension \*.mp4

Video Codec (Profile@Level) AVC / H.264 BP@L3, MP@L4.2, HP@L4.2

Audio Codec AAC-LC / HE-AAC v1 / HE-AAC v2 / AC3 / E-AC3 / MPEG1L1 / MPEG1L2

Supported Subtitle Type External

Supported Maximum Resolution 1920x1080

Supported Minimum Resolution QCIF (176x144)

Supported Maximum Frame Rate 1920x1080@120fps

---

Video Codec (Profile@Level) MPEG4 SP@L6, ASP@L5, ACEP@L4

Audio Codec AAC-LC / HE-AAC v1 / HE-AAC v2 / AC3 / E-AC3 / MPEG1L1 / MPEG1L2

Supported Subtitle Type External

Supported Maximum Resolution 1920x1080

Supported Minimum Resolution QCIF (176x144)

Supported Maximum Frame Rate 1920x1080@30fps / 1280x720@60fps

---

- avi

---

Extension \*.avi

Video Codec (Profile@Level) Xvid

Audio Codec MPEG1L1 / MPEG1L2 / MPEG1L3 / AC3 / E-AC3

Supported Subtitle Type External

Supported Maximum Resolution 1920x1080

Supported Minimum Resolution QCIF (176x144)

Supported Maximum Frame Rate 1920x1080@30fps / 1280x720@60fps

---

Video Codec (Profile@Level) Motion JPEG  
Audio Codec  $\mu$ -LAW / PCM (U8) / PCM (S16LE)  
Supported Subtitle Type External  
Supported Maximum Resolution 1280x720  
Supported Minimum Resolution QCIF (176x144)  
Supported Maximum Frame Rate 1280x720@30fps

---

- Asf

---

Extension \*.asf

Video Codec (Profile@Level) VC1 AP@L3, MP@HL, SP@ML  
Audio Codec WMA9 Standard  
Supported Subtitle Type External  
Supported Maximum Resolution 1920x1080  
Supported Minimum Resolution QCIF (176x144)  
Supported Maximum Frame Rate 1920x1080@30fps / 1280x720@60fps

---

Extension \*.wmv

Video Codec (Profile@Level) VC1 AP@L3, MP@HL, SP@ML  
Audio Codec WMA9 Standard  
Supported Subtitle Type External  
Supported Maximum Resolution 1920x1080  
Supported Minimum Resolution QCIF (176x144)  
Supported Maximum Frame Rate 1920x1080@30fps / 1280x720@60fps

---

- MKV

---

Extension \*.mkv

Video Codec (Profile@Level) Xvid  
Audio Codec DTS core / AC3 / AAC-LC / E-AC3 / HE-AACv1 / HE-AAC v2 / MPEG1L1 / MPEG1L2 / Vorbis  
Supported Subtitle Type Internal / External  
Supported Maximum Resolution 1920x1080  
Supported Minimum Resolution QCIF (176x144)  
Supported Maximum Frame Rate 1920x1080@30fps / 1280x720@60fps

---

Video Codec (Profile@Level) AVC / H.264 BP@L3, MP@L4.2, HP@L4.2  
Audio Codec DTS core / AC3 / AAC-LC / E-AC3 / HE-AACv1 / HE-AAC v2 / MPEG1L1 / MPEG1L2 / Vorbis  
Supported Subtitle Type Internal / External  
Supported Maximum Resolution 1920x1080  
Supported Minimum Resolution QCIF (176x144)  
Supported Maximum Frame Rate 1920x1080@60fps

---

Video Codec (Profile@Level) MPEG4 SP@L6, ASP@L5, ACEP@L4  
Audio Codec DTS core / AC3 / AAC-LC / E-AC3 / HE-AACv1 / HE-AAC v2 / MPEG1L1 / MPEG1L2 / Vorbis  
Supported Subtitle Type Internal / External  
Supported Maximum Resolution 1920x1080

Supported Minimum Resolution QCIF (176x144)

Supported Maximum Frame Rate 1920x1080@30fps / 1280x720@60fps

---

Video Codec (Profile@Level) VP8

Audio Codec DTS core / AC3 / AAC-LC / E-AC3 / HE-AACv1 / HE-AAC v2 / MPEG1L1 / MPEG1L2 / Vorbis

Supported Subtitle Type Internal / External

Supported Maximum Resolution 1920x1080

Supported Minimum Resolution QCIF (176x144)

Supported Maximum Frame Rate 1920x1080@30fps / 1280x720@60fps

---

- 3gpp

---

Extension \*.3gp / \*.3g2

Video Codec (Profile@Level) MPEG4 SP@L6, ASP@L5, ACEP@L4

Audio Codec AAC-LC / HE-AAC v1 / HE-AAC v2 / AC3 / E-AC3 / MPEG1L1 / MPEG1L2

Supported Subtitle Type External

Supported Maximum Resolution 1920x1080

Supported Minimum Resolution QCIF (176x144)

Supported Maximum Frame Rate 1920x1080@30fps / 1280x720@60fps

---

Video Codec (Profile@Level) AVC / H.264 BP@L3, MP@L4.2, HP@L4.2

Audio Codec AAC-LC / HE-AAC v1 / HE-AAC v2 / AC3 / E-AC3 / MPEG1L1 / MPEG1L2

Supported Subtitle Type External

Supported Maximum Resolution 1920x1080

Supported Minimum Resolution QCIF (176x144)

Supported Maximum Frame Rate 1920x1080@60fps

---

- MOV

---

Extension \*.mov

Video Codec (Profile@Level) AVC / H.264 BP@L3, MP@L4.2, HP@L4.2

Audio Codec AAC-LC / HE-AAC v1 / HE-AAC v2 / AC3 / E-AC3 / MPEG1L1 / MPEG1L2 /  $\mu$ -LAW / PCM (U8) / PCM (S16BE) / PCM (S16LE)

Supported Subtitle Type External

Supported Maximum Resolution 1920x1080

Supported Minimum Resolution QCIF (176x144)

Supported Maximum Frame Rate 1920x1080@60fps

---

Video Codec (Profile@Level) MPEG4 SP@L6, ASP@L5, ACEP@L4

Audio Codec AAC-LC / HE-AAC v1 / HE-AAC v2 / AC3 / E-AC3 / MPEG1L1 / MPEG1L2 /  $\mu$ -LAW / PCM (U8) / PCM (S16BE) / PCM (S16LE)

Supported Subtitle Type External

Supported Maximum Resolution 1920x1080

Supported Minimum Resolution QCIF (176x144)

Supported Maximum Frame Rate 1920x1080@30fps / 1280x720@60fps

---

Video Codec (Profile@Level) Motion JPEG

Audio Codec AAC-LC / HE-AAC v1 / HE-AAC v2 / AC3 / E-AC3 / MPEG1L1 / MPEG1L2 /  $\mu$ -LAW / PCM (U8) / PCM (S16BE) / PCM (S16LE)

Supported Subtitle Type External

Supported Maximum Resolution 1280x720

Supported Minimum Resolution QCIF (176x144)

Supported Maximum Frame Rate 1280x720@30fps

---

- WebM

---

Extension \*.webm

Video Codec (Profile@Level) VP8

Audio Codec Vorbis

Supported Subtitle Type Internal / External

Supported Maximum Resolution 1920x1080

Supported Minimum Resolution QCIF (176x144)

Supported Maximum Frame Rate 1920x1080@30fps / 1280x720@60fps

---

## Video (for 4K models)

Container: MPEG1 / MPEG2PS / MPEG2TS / MP4 / avi / Asf / MKV / 3gpp / MOV / WebM

- MPEG1

---

Extension \*.mpg / \*.mpe / \*.mpeg

Video Codec (Profile@Level) MPEG1

Audio Codec MPEG1L2

Supported Subtitle Type External

Supported Maximum Resolution 1920x1080

Supported Minimum Resolution QCIF (176x144)

Supported Maximum Frame Rate 1920x1080@30fps / 1280x720@60fps

---

- MPEG2PS

---

Extension \*.mpg / \*.mpe / \*.mpeg

Video Codec (Profile@Level) MPEG2 MP@HL, MP@H14L, MP@ML

Audio Codec MPEG1L1 / MPEG1L2 / LPCM / AC3

Supported Subtitle Type External

Supported Maximum Resolution 1920x1080

Supported Minimum Resolution QCIF (176x144)

Supported Maximum Frame Rate 1920x1080@30fps / 1280x720@60fps

---

- MPEG2TS

---

Extension \*.m2t

Video Codec (Profile@Level) MPEG2 MP@HL, MP@H14L, MP@ML

Audio Codec MPEG1L1 / MPEG1L2 / AAC-LC / HE-AAC v1 / HE-AAC v2 / AC3 / E-AC3

Supported Subtitle Type -

Supported Maximum Resolution 1920x1080

Supported Minimum Resolution QCIF (176x144)

Supported Maximum Frame Rate 1920x1080@30fps / 1280x720@60fps

---

Extension \*.m2ts / \*.mts

Video Codec (Profile@Level) AVC / H.264 BP@L3, MP@L4.2, HP@L4.2

Audio Codec MPEG1L1 / MPEG1L2 / AAC-LC / HE-AAC v1 / HE-AAC v2 / AC3 / E-AC3

Supported Subtitle Type -

Supported Maximum Resolution 1920x1080

Supported Minimum Resolution QCIF (176x144)

Supported Maximum Frame Rate 1920x1080@60fps

---

## ● MP4

Extension \*.mp4

Video Codec (Profile@Level) AVC / H.264 BP@L3, MP@L4.2, HP@L4.2

Audio Codec AAC-LC / HE-AAC v1 / HE-AAC v2 / AC3 / E-AC3 / MPEG1L1 / MPEG1L2

Supported Subtitle Type External

Supported Maximum Resolution 1920x1080

Supported Minimum Resolution QCIF (176x144)

Supported Maximum Frame Rate 1920x1080@120fps

---

Video Codec (Profile@Level) MPEG4 SP@L6, ASP@L5, ACEP@L4

Audio Codec AAC-LC / HE-AAC v1 / HE-AAC v2 / AC3 / E-AC3 / MPEG1L1 / MPEG1L2

Supported Subtitle Type External

Supported Maximum Resolution 1920x1080

Supported Minimum Resolution QCIF (176x144)

Supported Maximum Frame Rate 1920x1080@30fps / 1280x720@60fps

---

Video Codec (Profile@Level) AVC/H.264 BP@L5.2, MP@L5.2, HP@L5.2

Audio Codec AAC-LC/HE-AAC v1/HE-AAC v2/AC3/E-AC3/LPCM

Supported Subtitle Type External

Supported Maximum Resolution 3840x2160

Supported Minimum Resolution QCIF (176x144)

Supported Maximum Frame Rate 3840x2160@60p / 1920x1080@120fps

---

Video Codec (Profile@Level) HEVC/H.265 MP@L5.1, Main10@L5.1

Audio Codec AAC-LC/HE-AAC v1/HE-AAC v2/AC3/E-AC3

Supported Subtitle Type External

Supported Maximum Resolution 3840x2160

Supported Minimum Resolution QCIF (176x144)

Supported Maximum Frame Rate 3840x2160@60p

---

- avi

---

Extension \*.avi

Video Codec (Profile@Level) Xvid

Audio Codec MPEG1L1 / MPEG1L2 / MPEG1L3 / AC3 / E-AC3

Supported Subtitle Type External

Supported Maximum Resolution 1920x1080

Supported Minimum Resolution QCIF (176x144)

Supported Maximum Frame Rate 1920x1080@30fps / 1280x720@60fps

---

Video Codec (Profile@Level) Motion JPEG

Audio Codec  $\mu$ -LAW / PCM (U8) / PCM (S16LE)

Supported Subtitle Type External

Supported Maximum Resolution 1280x720

Supported Minimum Resolution QCIF (176x144)

Supported Maximum Frame Rate 1280x720@30fps

---

- Asf

---

Extension \*.asf

Video Codec (Profile@Level) VC1 AP@L3, MP@HL, SP@ML

Audio Codec WMA9 Standard

Supported Subtitle Type External

Supported Maximum Resolution 1920x1080

Supported Minimum Resolution QCIF (176x144)

Supported Maximum Frame Rate 1920x1080@30fps / 1280x720@60fps

---

Extension \*.wmv

Video Codec (Profile@Level) VC1 AP@L3, MP@HL, SP@ML

Audio Codec WMA9 Standard

Supported Subtitle Type External

Supported Maximum Resolution 1920x1080

Supported Minimum Resolution QCIF (176x144)

Supported Maximum Frame Rate 1920x1080@30fps / 1280x720@60fps

---

- MKV

---

Extension \*.mkv

Video Codec (Profile@Level) Xvid

Audio Codec DTS core / AC3 / AAC-LC / E-AC3 / HE-AACv1 / HE-AAC v2 / MPEG1L1 / MPEG1L2 / Vorbis

Supported Subtitle Type Internal / External

Supported Maximum Resolution 1920x1080

Supported Minimum Resolution QCIF (176x144)

Supported Maximum Frame Rate 1920x1080@30fps / 1280x720@60fps

---

Video Codec (Profile@Level) AVC / H.264 BP@L3, MP@L4.2, HP@L4.2



Audio Codec DTS core / AC3 / AAC-LC / E-AC3 / HE-AACv1 / HE-AAC v2 / MPEG1L1 / MPEG1L2 / Vorbis  
Supported Subtitle Type Internal / External  
Supported Maximum Resolution 1920x1080  
Supported Minimum Resolution QCIF (176x144)  
Supported Maximum Frame Rate 1920x1080@60fps

---

Video Codec (Profile@Level) MPEG4 SP@L6, ASP@L5, ACEP@L4  
Audio Codec DTS core / AC3 / AAC-LC / E-AC3 / HE-AACv1 / HE-AAC v2 / MPEG1L1 / MPEG1L2 / Vorbis  
Supported Subtitle Type Internal / External  
Supported Maximum Resolution 1920x1080  
Supported Minimum Resolution QCIF (176x144)  
Supported Maximum Frame Rate 1920x1080@30fps / 1280x720@60fps

---

Video Codec (Profile@Level) AVC/H.264 BP@L5.2, MP@L5.2, HP@L5.2  
Audio Codec DTS core/AC3/AAC-LC/E-AC3/HE-AACv1/HE-AAC v2  
Supported Subtitle Type Internal / External  
Supported Maximum Resolution 3840x2160  
Supported Minimum Resolution QCIF (176x144)  
Supported Maximum Frame Rate 3840x2160@60p

---

Video Codec (Profile@Level) VP8  
Audio Codec DTS core / AC3 / AAC-LC / E-AC3 / HE-AACv1 / HE-AAC v2 / MPEG1L1 / MPEG1L2 / Vorbis  
Supported Subtitle Type Internal / External  
Supported Maximum Resolution 1920x1080  
Supported Minimum Resolution QCIF (176x144)  
Supported Maximum Frame Rate 1920x1080@30fps / 1280x720@60fps

---

Video Codec (Profile@Level) HEVC/H.265 MP@L5.1, Main10@L5.1  
Audio Codec DTS core/AC3/AAC-LC/E-AC3/HE-AACv1/HE-AAC v2  
Supported Subtitle Type Internal / External  
Supported Maximum Resolution 3840x2160  
Supported Minimum Resolution QCIF (176x144)  
Supported Maximum Frame Rate 3840x2160@60p

---

- 3gpp

Extension \*.3gp / \*.3g2

---

Video Codec (Profile@Level) MPEG4 SP@L6, ASP@L5, ACEP@L4  
Audio Codec AAC-LC / HE-AAC v1 / HE-AAC v2 / AC3 / E-AC3 / MPEG1L1 / MPEG1L2  
Supported Subtitle Type External  
Supported Maximum Resolution 1920x1080  
Supported Minimum Resolution QCIF (176x144)  
Supported Maximum Frame Rate 1920x1080@30fps / 1280x720@60fps

---

Video Codec (Profile@Level) AVC / H.264 BP@L3, MP@L4.2, HP@L4.2  
Audio Codec AAC-LC / HE-AAC v1 / HE-AAC v2 / AC3 / E-AC3 / MPEG1L1 / MPEG1L2  
Supported Subtitle Type External

Supported Maximum Resolution 1920x1080  
Supported Minimum Resolution QCIF (176x144)  
Supported Maximum Frame Rate 1920x1080@60fps

---

- MOV

Extension \*.mov

Video Codec (Profile@Level) AVC / H.264 BP@L3, MP@L4.2, HP@L4.2

Audio Codec AAC-LC / HE-AAC v1 / HE-AAC v2 / AC3 / E-AC3 / MPEG1L1 / MPEG1L2 /  $\mu$ -LAW / PCM (U8) / PCM (S16BE) / PCM (S16LE)

Supported Subtitle Type External

Supported Maximum Resolution 1920x1080

Supported Minimum Resolution QCIF (176x144)

Supported Maximum Frame Rate 1920x1080@60fps

---

Video Codec (Profile@Level) MPEG4 SP@L6, ASP@L5, ACEP@L4

Audio Codec AAC-LC / HE-AAC v1 / HE-AAC v2 / AC3 / E-AC3 / MPEG1L1 / MPEG1L2 /  $\mu$ -LAW / PCM (U8) / PCM (S16BE) / PCM (S16LE)

Supported Subtitle Type External

Supported Maximum Resolution 1920x1080

Supported Minimum Resolution QCIF (176x144)

Supported Maximum Frame Rate 1920x1080@30fps / 1280x720@60fps

---

Video Codec (Profile@Level) Motion JPEG

Audio Codec AAC-LC / HE-AAC v1 / HE-AAC v2 / AC3 / E-AC3 / MPEG1L1 / MPEG1L2 /  $\mu$ -LAW / PCM (U8) / PCM (S16BE) / PCM (S16LE)

Supported Subtitle Type External

Supported Maximum Resolution 1280x720

Supported Minimum Resolution QCIF (176x144)

Supported Maximum Frame Rate 1280x720@30fps

---

- WebM

Extension \*.webm

Video Codec (Profile@Level) VP8

Audio Codec Vorbis

Supported Subtitle Type Internal / External

Supported Maximum Resolution 1920x1080

Supported Minimum Resolution QCIF (176x144)

Supported Maximum Frame Rate 1920x1080@30fps / 1280x720@60fps

---

Audio Codec: LPCM / MPEG1L1 / MPEG1L2 / MPEG1L3 / AAC-LC / HE-AAC v1 / v2 / AC3 / E-AC3 / Vorbis / WMA9 / DTS core /  $\mu$ -LAW / PCM(U8) / PCM(S16LE) / PCM(S16BE)

- LPCM

---

Supported Sampling Rate 44.1k / 48k

---

- MPEG1L1 / MPEG1L2

---

Supported Sampling Rate 32k / 44.1k / 48k

---

- MPEG1L3

---

Supported Sampling Rate 32k / 44.1k / 48k

---

- AAC-LC

---

Supported Sampling Rate 16k / 22.05k / 24k / 32k / 44.1k / 48k

---

- HE-AAC v1 / v2

---

Supported Sampling Rate 24k / 32k / 44.1k / 48k

---

- AC3

---

Supported Sampling Rate 32k / 44.1k / 48k

---

- E-AC3

---

Supported Sampling Rate 32k / 44.1k / 48k

---

- Vorbis

---

Supported Sampling Rate 8k / 11.025k / 16k / 22.05k / 32k / 44.1k / 48k

---

- WMA9

---

Supported Sampling Rate 8k / 11.025k / 16k / 22.05k / 32k / 44.1k / 48k

---

- DTS core

---

Supported Sampling Rate 32k / 44.1k / 48k

---

- **$\mu$ -LAW**

---

Supported Sampling Rate 8k

---

- PCM(U8)

---

Supported Sampling Rate 8k

---

- PCM(S16LE)

---

Supported Sampling Rate 11.025k / 16k / 44.1k

---

- PCM(S16BE)

---

Supported Sampling Rate 11.025k / 16k / 44.1k

---

## External Subtitle

File Format: Substation Alpha / SubRip / MicroDVD / SubViewer / SAMI

- Substation Alpha

---

Extension \*.ass / \*.ssa

Supported Use Case USB

---

- SubRip

---

Extension \*.srt

Supported Use Case USB

---

- MicroDVD

---

Extension \*.sub / \*.txt

Supported Use Case USB

---

- SubViewer

---

Extension \*.sub

Supported Use Case USB

---

- SAMI

---

Extension \*.smi

Supported Use Case USB

---

